



# ORBCOMM

## System Overview

**ORBCOMM LLC**

21700 Atlantic Boulevard  
Dulles, Virginia 20166, U.S.A.

		Signature	Date
Prepared By:	<b>Sarah Reid</b> Documentation		
Approved By:	<b>Tim Maclay</b> Director, Systems Engineering		
Approved By:	<b>Dean Brickerd</b> Director, Applications Engineering		
Approved By:	<b>Robert Burdett</b> Director, Space and Operations		
Approved By:	<b>Mike Lord</b> Director, Global Gateway Engineering		
Approved By:	<b>Todd Rudd</b> Director, GCC Engineering		



# **ORBCOMM**

## **System Overview**

**ORBCOMM LLC**

21700 Atlantic Boulevard  
Dulles, Virginia 20166, U.S.A.

Date: December 18, 2001

A80TD0008 - Revision G

### **EXPORT CONTROL STATEMENT**

The contents of this document, in whole or in part, shall not be exported from the United States, which export shall include, but not be limited to, transmittal to any non-U.S. citizen wherever said person is located, except in accordance with all United States laws and regulations relating to exports and to all administrative acts of the U.S. Government pursuant to such laws and regulations. Diversion, re-export or transshipment of the contents of this document, in whole or in part, contrary to U.S. law is also strictly prohibited.

## PREFACE

1. This publication contains a basic technical overview of the ORBCOMM System.
2. To obtain information relative to this or other ORBCOMM documents, send an email to the following address:

DOCUMENT\_CONTROL@ORBCOMM.COM.

3. This publication supersedes the following document:

*ORBCOMM System Overview* (Document No. A80TD0008, Revision F).

# CONTENTS

## CHAPTER 1

<b>INTRODUCTION.....</b>	<b>1-1</b>
--------------------------	------------

<b>CHAPTER 2 SYSTEM DESCRIPTION.....</b>	<b>2-1</b>
--	------------

2.1 MULTIPLE ACCESS PROTOCOLS .....	2-2
2.2 ORBCOMM SERVICE ELEMENTS .....	2-3
2.3 DYNAMIC CHANNEL ACTIVITY ASSIGNMENT SYSTEM.....	2-3
2.4 POSITION DETERMINATION CAPABILITIES .....	2-4

<b>CHAPTER 3 GROUND INFRASTRUCTURE .....</b>	<b>3-1</b>
--	------------

3.1 OVERVIEW OF THE ORBCOMM GATEWAY.....	3-1
3.1.1 Gateway Message Switching System .....	3-3
3.1.2 Message Distribution Center .....	3-4
3.1.3 Monitoring & Control .....	3-4
3.1.4 Gateway Earth Station.....	3-5
3.1.5 ORBNet.....	3-7
3.2 GATEWAY CUSTOMER ACCESS INTERFACE OPTIONS .....	3-8
3.2.1 Public Data Networks .....	3-8
3.2.2 Leased Line Access.....	3-8
3.3 THE NETWORK CONTROL CENTER.....	3-9
3.4 GES-TO-SATELLITE CHANNELS.....	3-9
3.5 GES-TO-GCC CHANNELS .....	3-9
3.6 SUBSCRIBER COMMUNICATORS .....	3-9

<b>SPACE SEGMENT.....</b>	<b>4-1</b>
---------------------------	------------

4.1 CONSTELLATION COVERAGE AND AVAILABILITY .....	4-1
4.2 SYSTEM REDUNDANCY.....	4-2
4.3 OPERATIONAL FREQUENCIES AND CHANNELIZATION PLAN .....	4-2
4.4 SATELLITE DESCRIPTION .....	4-3
4.1.1 Communication Payload .....	4-4
4.1.2 Antenna Pattern .....	4-5
4.1.3 Attitude Control System.....	4-6

<b>CHAPTER 5 SATELLITE CONNECTION MANAGEMENT.....</b>	<b>5-1</b>
---	------------

5.1 SATELLITE-GES CONNECTIONS.....	5-1
5.1.1 Establishing Connections .....	5-1
5.1.2 Satellite Selection Process.....	5-2
5.2 SC NETWORKING.....	5-2

<b>APPENDIX A DATA SESSION DESCRIPTIONS .....</b>	<b>A-1</b>
---	------------

A.1 INTRODUCTION .....	A-1
A.2 DATA SESSION SETUP.....	A-1

A.3	SC-ORIGINATED MESSAGE TRANSFER.....	A-1
A.3.1	Acquire/Communicate .....	A-1
A.3.2	Longer Message Transfer (Messages) .....	A-2
A.4	SC-TERMINATED MESSAGE TRANSFER.....	A-2
A.5	GLOBALGRAMS .....	A-5
A.5.1	SC-Originated GlobalGrams .....	A-5
A.5.2	SC-Terminated GlobalGrams .....	A-5
A.6	SC-TO-SC MESSAGING .....	A-5
<b>ORBCOMM CONSTELLATION ORBITAL PARAMETERS .....</b>		<b>B-1</b>
<b>ORBCOMM LINK BUDGET PARAMETERS .....</b>		<b>C-1</b>
C.1	INTRODUCTION .....	C-1
C.2	GES-TO-SATELLITE LINK BUDGET .....	C-1
C.3	SATELLITE-TO-SUBSCRIBER LINK BUDGET .....	C-3
C.4	SUBSCRIBER-TO-SATELLITE LINK BUDGET .....	C-4
C.5	SATELLITE-TO-GATEWAY LINK BUDGET.....	C-5
C.6	UHF TRANSMITTER LINK BUDGET .....	C-6
<b>SATELLITE FREQUENCY &amp; POLARIZATION PLAN.....</b>		<b>D-1</b>
<b>APPENDIX E FREQUENCY SHARING ASPECT OF THE ORBCOMM SYSTEM.....</b>		<b>E-1</b>
E.1	137-138 MHz SPACE-TO-EARTH FREQUENCY BAND .....	E-1
E.1.1	Satellite Power Flux Density Threshold Limit .....	E-1
E.1.2	Frequency Sharing with Incumbent Users .....	E-1
E.1.3	Frequency Sharing with New Users .....	E-2
E.2	148-149.9 MHz EARTH-TO-SPACE FREQUENCY BAND.....	E-2
E.2.1	Level 1 - DCAAS.....	E-2
E.2.2	Level 2 - Low Probability of Proximity .....	E-5
E.2.3	Level 3 - Short Duration Signals .....	E-5
E.2.4	Level 4 - Signal Structure Reduces Interference .....	E-5
E.3	OUT-OF-BAND SHARING .....	E-6
E.3.1	Radio Astronomy in the 150.05-153 & 406.1-410 MHz Bands.....	E-6
E.3.2	Aeronautical System in the 136-137 MHz Band.....	E-7
<b>APPENDIX F LIST OF ACRONYMS .....</b>		<b>F-1</b>

## LIST OF FIGURES

FIGURE 2.1 - ORBCOMM SYSTEM OVERVIEW .....	2-2
FIGURE 3.1 - THE ORBCOMM GATEWAY .....	3-1
FIGURE 4.1 - ORBCOMM SYSTEM SATELLITE CONSTELLATION .....	4-1
FIGURE 4.2 - MAIN PARTS OF A FULLY DEPLOYED SATELLITE.....	4-3
FIGURE 4.3 - SATELLITE SUBSCRIBER ANTENNA GAIN PATTERNS .....	4-5
FIGURE 5.1 - RELATIONSHIP OF ORBCOMM PROTOCOL STACK TO SATELLITE CONNECTIONS ..	5-1
FIGURE A.1 - SC-ORIGINATED MESSAGE TRANSFER SESSION .....	A-3
FIGURE A.2 – SC - TERMINATED MESSAGE TRANSFER SESSION.....	A-4
FIGURE E.1 - DCAAS OPERATION .....	E-3
FIGURE E.2 - MES DATA TRANSFER SESSION FLOWCHART .....	E-6

## LIST OF TABLES

TABLE 3.1 - TYPICAL SUBSCRIBER COMMUNICATOR SPECIFICATIONS .....	3-10
TABLE 4.1 - ORBCOMM SYSTEM SATELLITE CHANNEL ALLOCATION .....	4-2
TABLE B.1 - CONSTELLATION ORBITAL PARAMETERS .....	B-1
TABLE C.1 - ORBCOMM GES-TO-SATELLITE UPLINK BUDGET .....	C-2
TABLE C.2 - SATELLITE-TO-SUBSCRIBER LINK BUDGET.....	C-3
TABLE C.3 - SUBSCRIBER-TO-SATELLITE LINK BUDGET.....	C-4
TABLE C.4 - SATELLITE-TO-GATEWAY LINK BUDGET.....	C-5
TABLE C.5 - UHF-TO-SUBSCRIBER DOWNLINK BUDGET.....	C-6
TABLE D.1 - 137.0-138.0 MHz DOWNLINK CHANNELIZATION AND POLARIZATION PLAN.....	D-1
TABLE D.2 - 148-150.05 MHz UPLINK CHANNELIZATION AND POLARIZATION PLAN .....	D-2
TABLE E.1 - OUT-OF-BAND EMISSIONS INTO RADIO ASTRONOMY BANDS .....	E-7

CHANGE SUMMARY			
Change	Date	Change Description	Page(s)
Revision G	12/18/2001	<ul style="list-style-type: none"><li>Revision G updates the ORBCOMM System Overview to reflect new ownership by ORBCOMM LLC</li></ul>	i-iii



# Chapter 1 INTRODUCTION

The *ORBCOMM System Overview* provides a technical summary of the ORBCOMM satellite communications system (herein called the ORBCOMM System). The document contains the following chapters:

- *Chapter 2, System Description* provides a general description of the ORBCOMM System.
- *Chapter 3, Ground Infrastructure* describes the ground infrastructure of the ORBCOMM System.
- *Chapter 4, Space Segment* describes the space segment of the ORBCOMM System.
- *Chapter 5, Satellite Connection Management* provides details about the connections to ORBCOMM satellites.

Appendixes A through E contain detailed technical information on various aspects of the ORBCOMM System, such as frequency sharing with other data communication systems, radio frequency (RF) link communications budgets, and frequency plans.

Appendix F contains a glossary of acronyms.

## Chapter 2 SYSTEM DESCRIPTION

The ORBCOMM System is a wide area, packet switched, two-way data communication system. Communications between Subscriber Communicators (SCs) and ORBCOMM Gateways are accomplished via a constellation of low-earth orbit (LEO) satellites. ORBCOMM Gateways are connected to dial-up circuits, private dedicated lines, or the Internet.

The ORBCOMM System consists of the ground infrastructure, a space segment, and a subscriber segment. A Network Control Center (NCC) manages the overall system worldwide.

- The ground infrastructure (discussed in Chapter 3) contains the ORBCOMM Gateway, which provides message processing and subscriber management.
- The space segment (discussed in Chapter 4) currently consists of 35 LEO satellites and one Satellite Control Center (SCC).
- The subscriber segment (discussed in Section 3.6) consists of the SCs used by ORBCOMM System subscribers to transmit information to and receive information from the LEO satellites.

RF communication within the ORBCOMM System operates in the very high frequency (VHF) portion of the frequency spectrum, between 137 and 150 Megahertz (MHz). The ORBCOMM satellites have a subscriber transmitter that provides a continuous 4800-bps stream of downlink packet data. (The downlink is capable of transmitting at 9600 bps.) Each satellite also has multiple subscriber receivers that receive short bursts from the SCs at 2400 bps. The ORBCOMM System is capable of providing low-bit-rate wireless data communications service around the world.

All communications within the ORBCOMM System must pass through an ORBCOMM Gateway. An ORBCOMM Gateway consists of a Gateway Control Center (GCC)—the facility that houses the computer hardware and software that manages and monitors message traffic—and a Gateway Earth Station (GES). The GES provides the link between the satellite constellation and an ORBCOMM GCC.

**EXAMPLE:** A user located in a remote location, out of range of a cellular telephone system, wants to send an email message to another user's home computer. The home computer is attached to the Internet via an email account. The messaging sequence, using the ORBCOMM System, proceeds as follows:

1. The remote user, equipped with a laptop computer and an ORBCOMM SC, composes an email message on the laptop. The user downloads the message to the SC.
2. The SC waits for a satellite to come into view. When it receives a satellite's downlink broadcast, it transmits the message to a satellite, which in turn receives, reformats, and relays the message to a GES.
3. The GES transmits the message over a dedicated line to the GCC. The GCC places the message on the public switched network for delivery to the recipient's Internet service provider (ISP).

4. After logging onto the Internet via the ISP, the recipient downloads the email message.

If the user at the home computer wants to reply to the remote user, the messaging sequence occurs in the reverse order: from the home computer to the Internet over a public switched network, from the ISP to the GCC, from the GCC to the GES, from the GES to a satellite, and finally from the satellite to an SC and from the SC to the user display.

The interrelationship of the ORBCOMM System elements is shown in Figure 2.1.

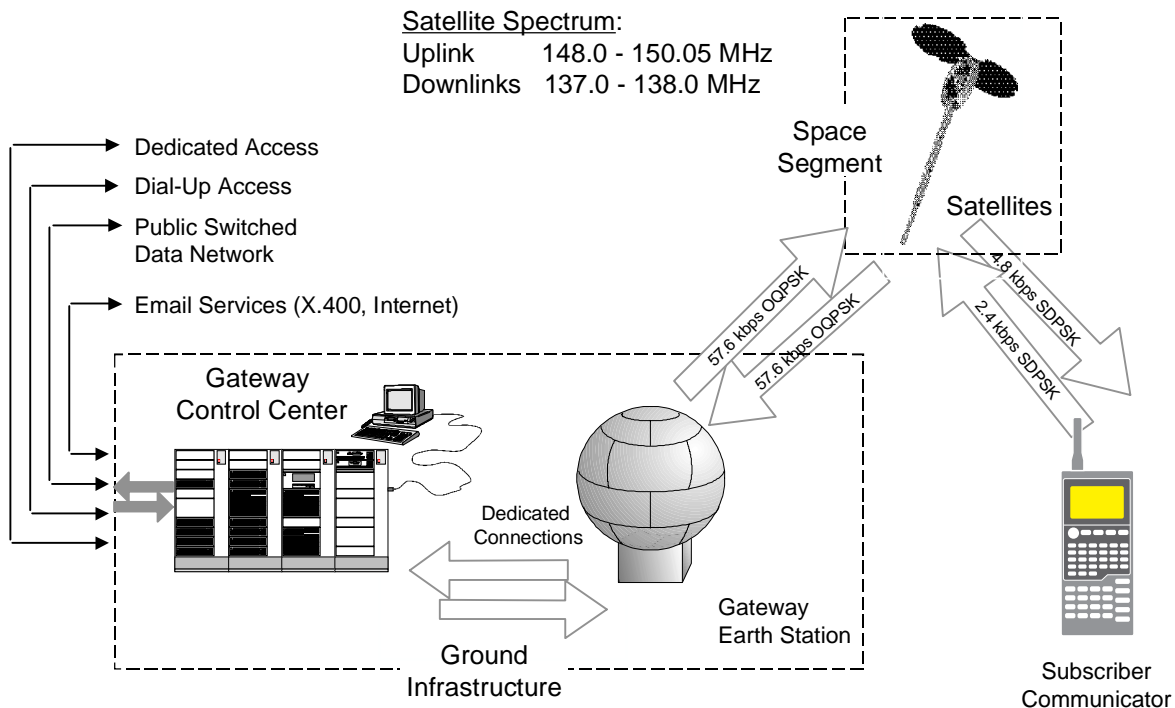

Figure 2.1 - ORBCOMM System Overview

## 2.1 Multiple Access Protocols

Communication from an SC to the satellite constellation is divided between two different types of communication channels: random access channels and reservation/messaging channels. The NCC controls the number of satellite receivers assigned to these two channel types.

Information exchanged on the random access channels permits either short reports or control packets to be passed between the GCC's Gateway Message Switching System (GMSS) and the SC, or permits the ORBCOMM System to assign a messaging channel to an SC for transferring longer message packets.

The satellite downlink channel distributes information based on the satellite/ORBCOMM Gateway connection being used; the current random access uplink frequencies selected by the ORBCOMM System; and other pertinent ORBCOMM System information. This

information is updated every few seconds. The basic multiple access process contains modifications to a standard Aloha scheme.

**NOTE:** *Appendix A, Data Session Descriptions* provides more details on message transfer descriptions.

## 2.2 ORBCOMM Service Elements

There are four basic service elements that the ORBCOMM System is capable of providing: Data Reports, Messages, GlobalGrams, and Commands.

**Data Reports.** A Data Report is the basic service element an SC uses to transmit or receive a single packet containing 6 bytes or less of user-defined data. A Data Report is transmitted via the random access protocol and may be generated as needed or on a periodic basis. A Data Report may be sent on request—polled by the ORBCOMM System—or may be sent when data are available. A Data Report can require an acknowledgment of successful delivery to the ORBCOMM Gateway, but such acknowledgment may be omitted to save space segment resources.

**Messages.** A Message is the basic service element an SC uses to transmit or receive a longer sequence of data. Messages typically have lengths less than 100 bytes, although the ORBCOMM System can handle longer Messages. To ensure reliability, Messages are transferred over the satellite reservation channels via short packets containing a checksum, with all packets acknowledged or retransmitted. Messages are accepted/delivered via public or private data networks. SC-Originated Messages may be generated at the request of the subscriber (random access) or at the request of the network (polled). In either case, Message packets are transferred in a reservation (polled) fashion.

**NOTE:** The term “message” with a lower case “m” refers to raw subscriber data. The term “Message” with an upper case “M” refers to subscriber data that are segmented, encapsulated, sequenced, and transmitted using the ORBCOMM System.

**GlobalGrams.** A GlobalGram is the basic service element an SC uses to transmit or receive a single, self-contained data packet to or from a satellite that is not in view of an ORBCOMM Gateway. This allows remote and oceanic areas to be served in a “store-and-forward” mode. For an SC-Terminated GlobalGram, the relaying satellite stores the data packet in memory and transmits it upon request from the destination SC. An SC-Terminated GlobalGram contains 182 bytes of user data. For an SC-Originated GlobalGram, the satellite receives the GlobalGram from the SC, acknowledges it and archives it in satellite memory until the destination ORBCOMM Gateway establishes contact with the satellite. An SC-Originated GlobalGram contains 229 bytes of user data.

**Commands.** A Command is the basic service element used to transmit a single packet containing 5 bytes or less of user-defined data. Commands may be signals to initiate action by devices attached to the SC. Acknowledgments may or may not be required.

## 2.3 Dynamic Channel Activity Assignment System

The ORBCOMM System earth-to-satellite uplinks are designed to operate in the 148-150.05 MHz band, which is shared worldwide with terrestrial communication services.

The heart of uplink interference avoidance is the Dynamic Channel Activity Assignment System (DCAAS). DCAAS uses a scanning receiver aboard each satellite that is capable of measuring the interference power across the entire uplink band. DCAAS scans subscriber uplink bands, identifies clear channels, and assigns those clear channels for uplink use by the SCs. It is designed to evaluate the channel assignments at intervals of 5 seconds or less.

The satellite processes the interference information to identify a list of preferred uplink channels. The channels are prioritized in terms of interference power expected on the next scan. Information gathered from commercial service, as well as from simulations, indicates a high success rate in predicting channels that are likely to be free of terrestrial transmissions on the next band scan.

Based on scan data and other channel-selection criteria, DCAAS changes the assignment of uplink random access channels frequently. Each subscriber message transmission occurs on an uplink frequency selected by the satellite, and the selections can vary from burst to burst. DCAAS permits the ORBCOMM System to avoid harmful interference to the terrestrial mobile systems, while improving the quality of service provided to ORBCOMM subscribers.

The satellite uplink receivers and downlink transmitters are designed to be frequency agile, although satellite downlinks and GES uplinks operate at fixed frequency assignments. This design feature permits the ORBCOMM System to avoid generating and receiving interference in the 148-150.05 MHz band, and allows flexible use of the 137-138 MHz band. Data collected, including data from experimental payloads that preceded the commercial satellites, indicate that even during the “busy hour” a sufficient number of interference-free channels will be available.

## 2.4 Position Determination Capabilities

The ORBCOMM System provides sufficient information for SCs to perform Doppler positioning. Control information broadcast from satellites includes satellite position, velocity, and time. This control information is derived from the on-board Global Positioning System (GPS) receiver and the frequency of the downlink signal itself. The SC measures the satellite downlink frequency to determine the Doppler shift. The Doppler shift, time, satellite position, and satellite velocity represent one data point. After enough data points are gathered, the SC can calculate the Doppler position.

An ultra high frequency (UHF) beacon signal transmitted from the satellite can be used by SCs equipped with UHF receivers to improve the Doppler position accuracy.

**NOTE:** SCs are not currently equipped with UHF receivers.

Some SCs are equipped with internal GPS receivers and associated GPS antennas. This improves the position determination accuracy by receiving position data signals directly from the GPS satellites.

## Chapter 3 GROUND INFRASTRUCTURE

An ORBCOMM licensee requires a Gateway to connect to ORBCOMM satellites in view of its service area. An ORBCOMM Gateway consists of a GCC and one or more GES sites, as well as the network components that provide interfacility communications.

### 3.1 Overview of the ORBCOMM Gateway

The principal role of the ORBCOMM Gateway is to provide message processing and subscriber management for a defined service area. This role includes serving as the “home” for ORBCOMM System subscribers, as well as providing the interface between the subscriber and the interconnected public and private data networks and the Public Switched Telephone Network (PSTN).

Figure 3.1 shows an elementary schematic of an ORBCOMM Gateway.

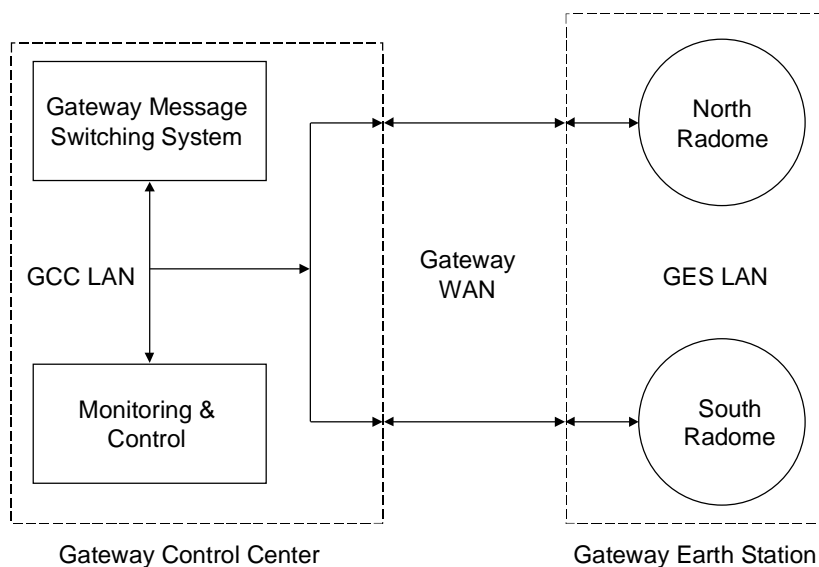

**Figure 3.1 - The ORBCOMM Gateway**

The GCC contains the GMSS and the Monitoring and Control (M&C) component. The M&C function allows GCC operators to manage hardware and software processes both within the GCC and at the remote GES sites, and to monitor the communications circuits between the sites. Each GES site contains two completely independent systems, each capable of communicating with one satellite. The network component (ORBNet) includes Local Area Networks (LANs) within the GCC and each GES, as well as the Wide Area Network (WAN) that provides interfacility communications.

The GCC is the operations center for ORBCOMM Gateway activities. Auxiliary systems such as the subscriber management and business support systems are typically located in the GCC. However, a GES is typically remotely located to provide optimum coverage for the required service area. Figure 3.2 illustrates the logical interconnection among the hardware elements incorporated in the GCC.

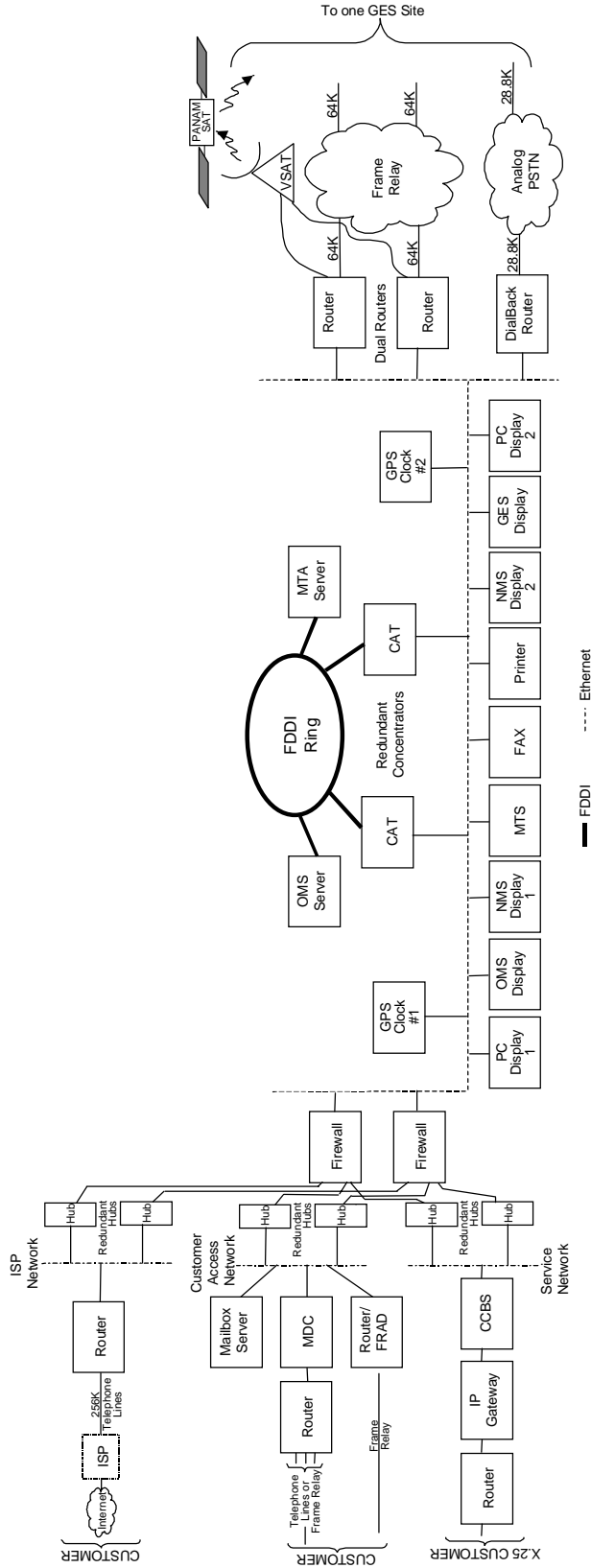

Figure 3.2 - ORBCOMM Gateway Control Center

### 3.1.1 Gateway Message Switching System

The GMSS contains the software that performs the actual message processing, routing, and conversion to and from X.400 and Simple Mail Transfer Protocol (SMTP). The ORBCOMM Gateway software converts the proprietary ORBCOMM protocol used for transmissions between the SC and the ORBCOMM Message Switch (OMS) to traditional X.400 formats, permitting processing using a commercial X.400 Message Transfer Agent (MTA). The portion of the ORBCOMM Gateway software that performs this conversion is called the ORBCOMM Message Gateway (OMG). This interface gives customer facilities equipped with an X.400 electronic mail system and access to public data networks a simple, standard connection to the ORBCOMM System. X.400 is a set of communication

protocol standards defined by the International Telecommunications Union-Telecommunications Standardization Sector (ITU-T). It is based on the Open Systems Interconnect (OSI) model and describes the basic components and service elements required to exchange messages between systems and users. The GMSS also provides an SMTP interface, called the SMTP Message Gateway, for customer facilities connected either to the Internet or over dedicated circuits.

The GMSS hardware is based on two servers, one hosting the OMS, the X.400 MTA, the SMTP Message Gateway, and OMG, and the other serving as a hot standby. In the event of a server failure, all software packages are respawned on the standby server.

**NOTE:** GMSS hardware is the responsibility of the ORBNet segment. The functional description was included here for the sake of readability.

Figure 3.3 illustrates the GMSS functions.

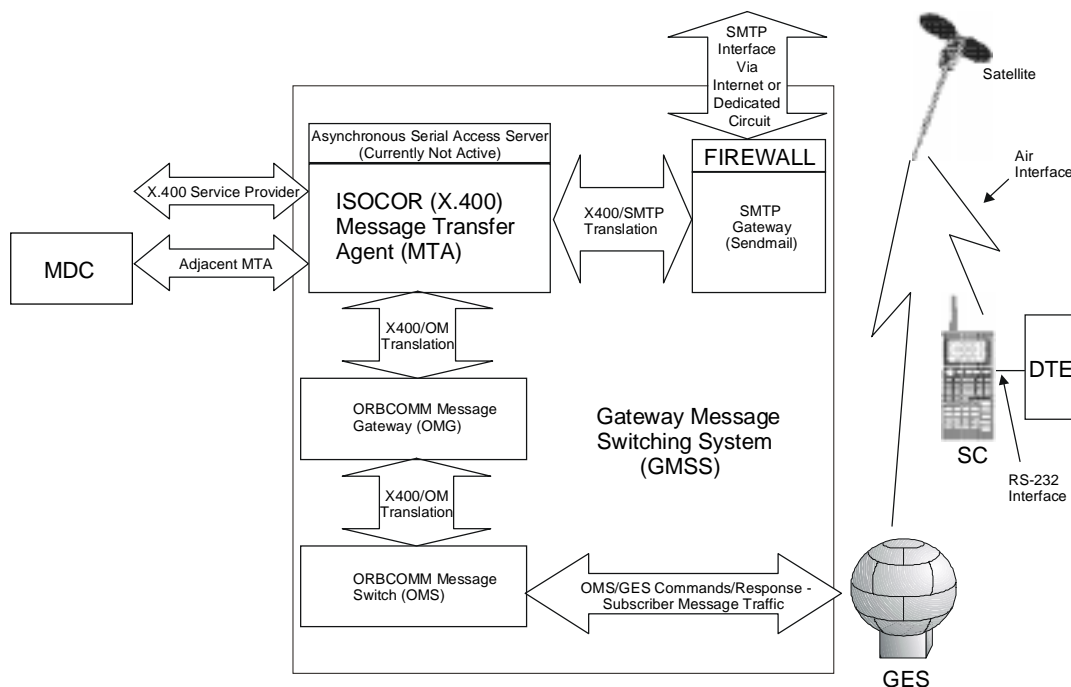

Figure 3.3 - Gateway Message Switching System Functions



### 3.1.2 Message Distribution Center

The optional Message Distribution Center (MDC) component provides message routing capability for all messages to and from SCs provisioned by an MDC Operator. An MDC connected to a GCC provides an alternative means of message management at a cost significantly less than the cost of owning an additional GCC. By controlling and managing messages to and from its customers, an MDC Operator can provide the following:

- customer care developed specifically to meet the needs of the customers;
- secure access into the ORBCOMM network;
- visibility into the message delivery process of the local Internet service provider and/or the local X.400 service provider;
- specialized applications (POP3 mailboxes);
- statistical compilation and reporting of message traffic;
- visibility into message traffic profiles; and
- control over messages for regulatory purposes.

Messages to or from the SC are routed through the appropriate MDC based on originating X.400 and SMTP addresses. The MDC is a group of fault tolerant servers, routers, hubs, and Uninterruptable Power Supplies (UPSs). All of the hardware and software components for the MDC, with the exception of the MDC Transfer Module (MTM), are available as commercial off-the-shelf (COTS) products. ORBCOMM's role in developing the MDC is that of a systems developer and integrator.

**NOTE:** The GESs available for use by an MDC may be located in sites that do not provide optimal coverage for that MDC's remote SCs.

### 3.1.3 Monitoring & Control

ORBCOMM M&C consists of the Network Management System (NMS) and a suite of core network monitoring tools. The NMS is a multi-user, distributed, fault- and event-monitoring and performance management software system that tracks and manages the ORBCOMM System. The NMS incorporates COTS tools and applications/enhancements developed by ORBCOMM.

Every NMS tool and utility is developed and integrated into Hewlett Packard OpenView Network Node Manager. NMS applications are developed as graphical user interfaces (GUIs) consisting of OpenView and X\_Windows/Motif screens. This gives the NMS a common GUI-based front end with a consistent look and feel.

Common NMS functions include the following:

- a visual display depicting the layout and status of the ORBCOMM network and all system components in a standard and consistent graphical format;
- an event filter and correlator;
- audio alarming for all critical system failures;

- collection and storage of system fault and performance data;
- Web-based reports;
- Graphical interfaces for most system administration tasks; and
- Real-time displays of OMS and GES information.

### 3.1.4 Gateway Earth Station

The mission of the GES is to provide an RF communications link between the OMS and the satellite constellation. It consists of medium gain tracking antennas, RF and modem equipment, and communications hardware and software for sending and receiving data packets. Figure 3.4 provides a functional block diagram of the GES.

The GES equipment and site are designed for unattended operation. The GES uses radome-enclosed, VHF full-motion antennas with approximately 17 dB of gain. Two fully independent antenna systems and associated RF and control equipment provide complete functional redundancy at a GES site. Figure 3.5 shows a photograph of GES radomes.

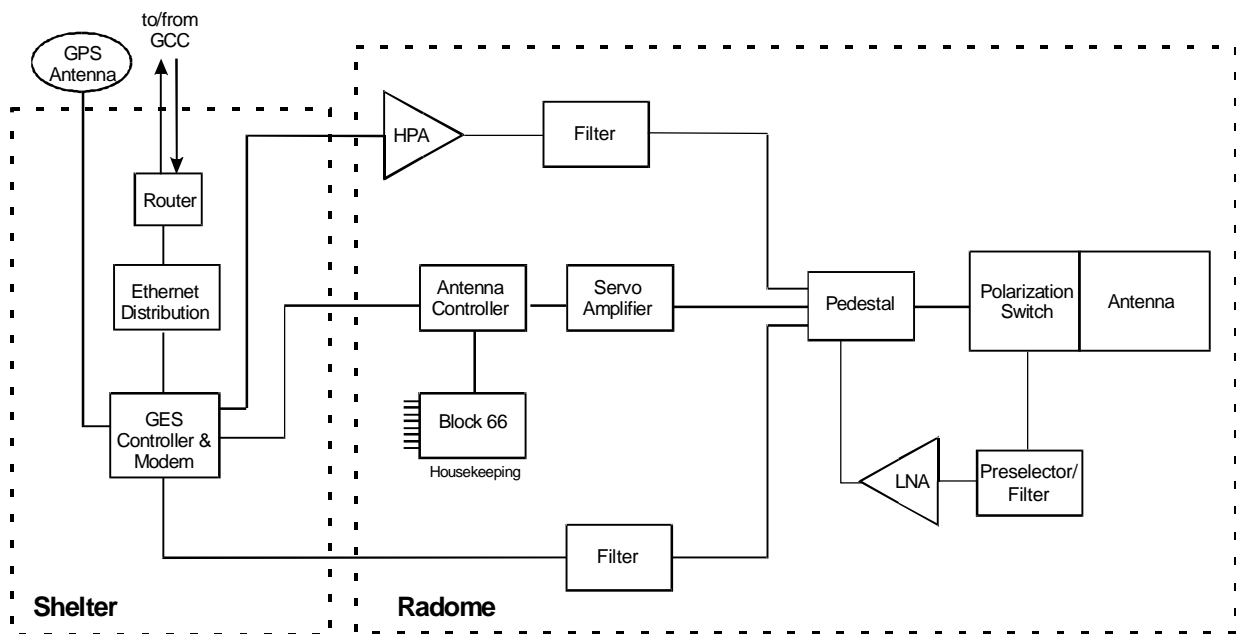

Figure 3.4 - Generic GES Functional Block Diagram



**Figure 3.5 - GES Radomes**

Figure 3.6 illustrates a typical GES site plan and provides minimum acceptable dimensions. Specific site details and dimensions must be prepared for each GES installation, considering local factors such as terrain, RF field-of-view, radiation hazard criteria, zoning, and other regulatory requirements.

Two licensee-provided communications lines (one for each antenna), each with a capacity of at least 56 kbps, form the communications link between each GES and the GCC. These lines can use one or more dedicated telephone data circuits, the Integrated Services Digital Network (ISDN), microwave circuits, or Very Small Aperture Terminal (VSAT) circuits.

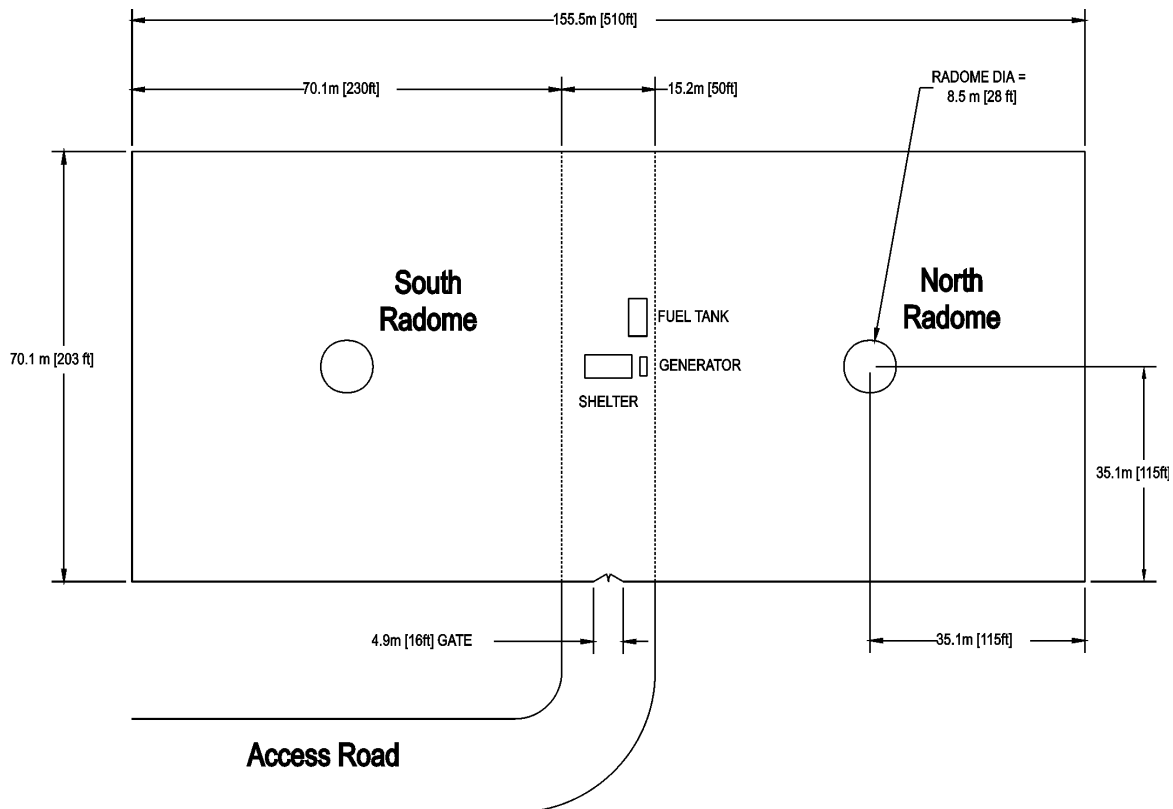

Figure 3.6 - Typical GES Site Plan

### 3.1.5 ORBNet

ORBNet consists of the WAN that connects a GCC to its GES sites, LANs within a GCC, LANs within each GES site, the WAN/LAN infrastructure, and the hardware and COTS software that support GCC and GES functionality. ORBNet also encompasses the world-wide WAN that provides communications between the NCC and international GCCs.

ORBNet functions include the following:

- providing message transport between an ORBCOMM Gateway GMSS and NMS;
- providing message transport between an ORBCOMM Gateway GCC and its GES sites;
- providing message transport within the GCC;
- providing inter-element communications within a GES site
- providing message transport between the U.S. NCC and international GCCs; and
- providing message transport between the ORBCOMM MTA and external customer MTAs via MDC.

The GCC-GES WAN may consist of a combination of dedicated telephone circuits, dial backup circuits, ISDN circuits, VSAT connections, terrestrial microwave links, T1/E1 or fractional T1/E1 circuits, frame relay circuits, and virtual private network (VPN) logical

circuits. A GCC-GES connection typically consists of routers that can switch between two physically diverse links. Each link must support a stream of at least 56 kbps, have a one-way transmission delay less than 1 second, have a link availability better than 99.5%, and support Internet protocols, including Transmission Control Protocol (TCP), User Datagram Protocol (UDP), Simple Network Management Protocol (SNMP), Open Shortest Path First (OSPF), and Internet Control Message Protocol (ICMP). The licensee is responsible for the design and maintenance of this WAN.

Ethernet LANs are commonly used within a facility. ORBCOMM Gateway designs dictate the LAN used for each application.

The WAN/LAN infrastructure includes routers, bridges, and modems. These components provide interconnections between the ORBCOMM Gateway elements (in particular, NMS, GMSS, and GES).

Hardware and COTS software include servers, computers used for NMS, firewalls, commercial databases, and other commercial software packages used within GCC and GES operations.

Inter-GCC communications are used for international telemetry and command. They may consist of VPNs over the Internet or frame relay connections.

## 3.2 Gateway Customer Access Interface Options

### 3.2.1 Public Data Networks

The ORBCOMM System offers the following options for gateway customer access interface:

- The ORBCOMM Gateway can have X.400 access. This access can be provided either by frame relay or by an X.25 packet switching network. An X.25 packet assembler/disassembler (PAD) is not allowed. Customer requirements for X.400 include a protocol stack of OSI/TP0/OSI-OSI-CONS/X.25.
- The ORBCOMM Gateway can have a dedicated link to the Internet. For SMTP access, customers must use a protocol stack of TCP/Internet Protocol (IP) and SMTP.

### 3.2.2 Leased Line Access

A user or reseller can use dedicated links to gain access to the X.400 MTA and SMTP electronic mail. ORBCOMM will support one of the following dedicated access technologies:

- TCP/IP; or
- OSI connectivity through leased lines.

For X.400 access, users or resellers must use a P2/TCP/IP or P2/OSI-TP4/OSI-CLNS protocol stack. For SMTP access, users or resellers must use a protocol stack of SMTP/TCP/IP.

### 3.3 The Network Control Center

The NCC manages the entire ORBCOMM satellite constellation and its processes, and analyzes all satellite telemetry. The NCC is responsible for managing the ORBCOMM System worldwide. Through ORBNet, the NCC monitors message traffic for the entire ORBCOMM System and also manages all message traffic that passes through the U.S. ORBCOMM Gateway.

The NCC is staffed 24 hours a day, 365 days a year and is located in Dulles, Virginia. A backup NCC will be established in 2000. It will permit recovery of critical NCC functions in the event of an NCC site failure.

### 3.4 GES-to-Satellite Channels

The RF links that connect an ORBCOMM Gateway GES to an ORBCOMM satellite are designed to use a single 57.6-kbps uplink and downlink channel using the TDMA protocol. This protocol permits simultaneous RF links between a single satellite and several GES installations within the satellite footprint. It also provides a virtually seamless hand-over of a satellite from GES to GES under the centralized control of the GMSS.

### 3.5 GES-to-GCC Channels

GES-to-GCC links will operate over 56-kbps or 64-kbps data lines. A typical installation consists of a Channel Service Unit/Data Service Unit (CSU/DSU) with a V.35 interface at both ends. TCP/IP IEEE 802.3 (Ethernet) packet routers, which provide link layer internetworking, connect these interfaces to the GCC and GES facilities. The GES process communicates with the GMSS process using TCP/IP UDP packets.

### 3.6 Subscriber Communicators

An SC is a wireless VHF modem that transmits messages from a user to the ORBCOMM System for delivery to an addressed recipient, and receives messages from the ORBCOMM System intended for a specific user. Manufacturers have different proprietary designs and are free to include unique features in their SC design. However, each design must be approved by ORBCOMM and adhere to the *ORBCOMM Air Interface Specification*, *Subscriber Communicator Specifications*, and *ORBCOMM Serial Interface Specification* (if an RS-232 port is available).

Different versions of SCs are currently available in production quantities. SCs now available include “black-box” industrial units that have RS-232C ports for data uploading and downloading. Current options on a number of SCs include internal GPS receivers and/or additional digital and analog input and output ports. Other models with different features are planned, under design, or in the pre-production stage.

The typical SC specifications are provided in Table 3.1.

Transmission Power	5 Watts
Receive Dynamic Range	-116 to -80 dBm
Sensitivity Performance	bit error rate of $10^{-5}$ at -116 dBm input
Power consumption (at +12 VDC)	
Sleep	< 1 mA
Receive	100 mA
Transmit	2 A
Operating Temperature	-30 to +60 °C
Approximate Size (First Generation)	15 cm (6 in.) x 15 cm (6 in.) x 5 cm (2 in.)
Weight (First Generation)	0.85 kg (30 ounces)
Typical Antenna Type	1/2 wave (1 meter) whip

**Table 3.1 - Typical Subscriber Communicator Specifications**

# Chapter 4 SPACE SEGMENT

## 4.1 Constellation Coverage and Availability

ORBCOMM has received a license to launch up to 47 satellites. The constellation consists of four planes of eight satellites each inclined at 45 degrees, two highly inclined planes of four satellites each, and one equatorial plane of seven satellites.

Currently, there are 35 satellites in orbit:

- Planes A, B, and C are inclined at 45° to the equator and each contain eight satellites in a circular orbit at an altitude of approximately 815 km (506 miles).
- Plane D, also inclined at 45°, contains seven satellites in a circular orbit at an altitude of 815 km (506 miles).
- Plane F is inclined at 70° and contains two satellites in a near-polar circular orbit at an altitude of 740 km (460 miles).
- Plane G is inclined at 108° and contains two satellites in a near-polar elliptical orbit at an altitude varying between 785 km (488 miles) and 875 km (544 miles).

The next launch is scheduled for the first quarter of 2001. Seven satellites will be placed in an equatorial orbit at an altitude of 975 km (606 miles). A subsequent launch is planned for the third quarter of 2001 to initiate replenishment of the main constellation.

Figure 4.1 illustrates the configuration of the ORBCOMM System satellite constellation.

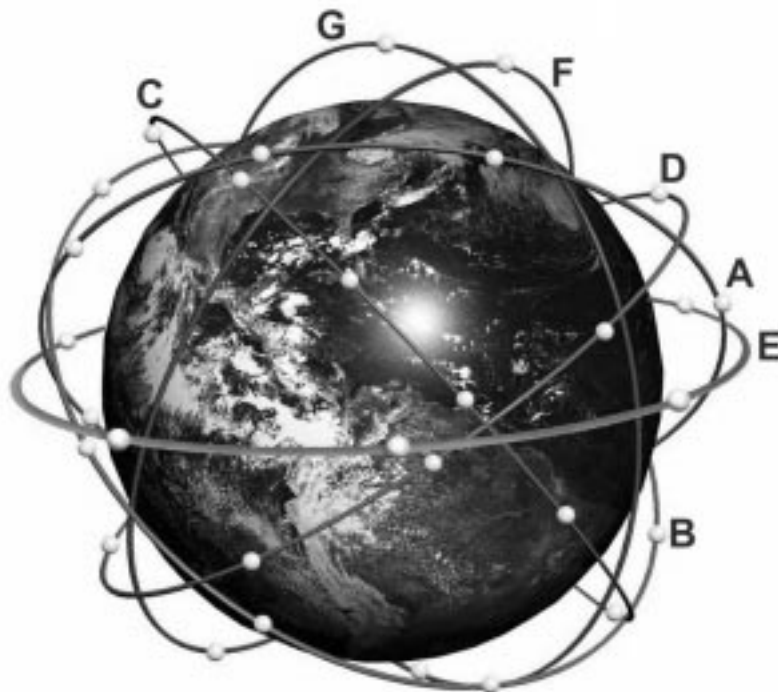

Figure 4.1 - ORBCOMM System Satellite Constellation



The amount of time available each day on the ORBCOMM satellite network depends on the number of satellites and gateways in operation and the user's location. As the satellites move with the Earth, so does the approximately 5100-km (3200-mile) diameter geometric footprint of each satellite.

**NOTE:** Current two-line orbital element sets (TLEs) for ORBCOMM satellites can be found by visiting the ORBCOMM Internet site, <http://www.orbcomm.com>, and clicking on the "Our Technology" link.

*Appendix B, ORBCOMM Constellation Orbital Parameters* provides additional details about the constellation.

## 4.2 System Redundancy

The ORBCOMM System provides redundancy at the system level due to the number of satellites in the constellation. In the event of a lost satellite, ORBCOMM will optimize the remaining constellation to minimize the time gaps in satellite coverage. Consequently, the ORBCOMM constellation is tolerant of degradations in the performance of individual satellites.

## 4.3 Operational Frequencies and Channelization Plan

Satellite RF downlinks to SCs and GESs are within the 137-138 MHz band. Downlink channels include 12 channels for transmitting to SCs and one Gateway channel, which is reserved for transmitting to the GESs. Each satellite transmits to SCs on one of the 12 subscriber downlink channels through a frequency-sharing scheme that provides four-fold channel reuse. Each ORBCOMM Gateway shares the single satellite/gateway downlink channel using a TDMA scheme. The transmission frequencies for these channels are listed in Table D.1 of *Appendix D, Satellite Frequency & Polarization Plan*.

SC RF uplink transmissions to the satellites occur within the 148-149.9-MHz band. SCs transmit at frequencies that are assigned to them dynamically by the satellite. The satellite receiver complement includes six uplink subscriber receivers, one DCAAS receiver, and one ORBCOMM Gateway receiver. The satellites also transmit a beacon signal at 400.1 MHz. This information is summarized in Table 4.1. Appendix D lists the frequency bands and channel requirements for the ORBCOMM System.

	No. of Channels	Spectrum	Data Rate
Satellite/Subscriber Downlink Channels	12 available, 1 assigned to each satellite	137-138 MHz	4.8/9.6 kbps
Satellite/Gateway Downlink Channel	1 available	137-138 MHz	57.6 kbps
Subscriber/Satellite Uplink Channels	6 available, DCAAS assigns the frequency	148-150.05 MHz	2.4 kbps
UHF Beacon	1 available	400.1 MHz	-

**Table 4.1 - ORBCOMM System Satellite Channel Allocation**

In selecting specific channel frequencies, a number of factors have been considered, including the current and future usage of the frequency bands of interest, and the effect on existing and planned systems.

## 4.4 Satellite Description

To date, 35 ORBCOMM satellites have been launched using Orbital Sciences Corporation's Pegasus<sup>®</sup> XL and Taurus<sup>®</sup> launch vehicles. Each of the satellites in the ORBCOMM satellite constellation is based on the Orbital Microstar<sup>™</sup> satellite bus. Undeployed, the ORBCOMM satellite resembles a disk weighing approximately 43 kg (90 lbs.), measuring approximately 1 meter (41 inches) in diameter and 16 cm (6.5 inches) in depth. The satellite solar panels and antennas fold up into the disk (also called the "payload shelf") with the remainder of the payload during launch and deployment. Once fully deployed, its length is approximately 4 meters (170 inches) and the distance across both deployed solar panels is approximately 2.2 meters (88 inches). Figure 4.2 shows the main parts of a fully deployed satellite.

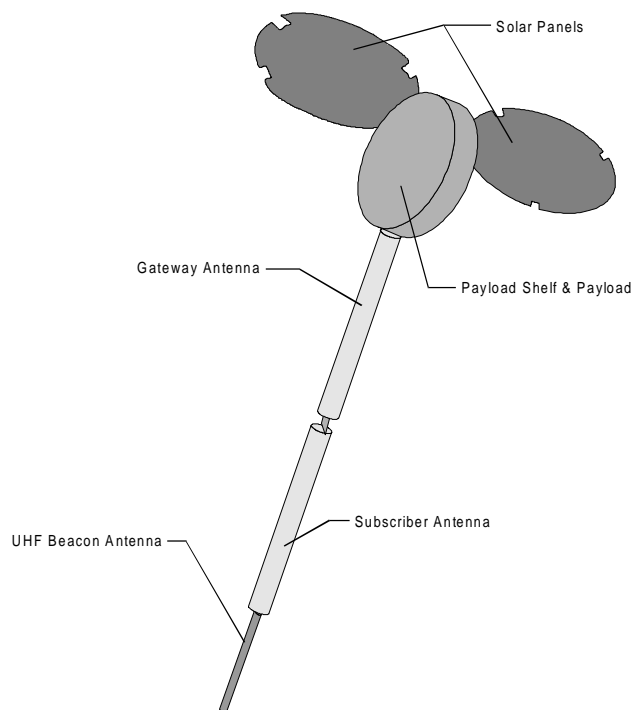

**Figure 4.2 - Main Parts of a Fully Deployed Satellite**

The satellite's electrical power system is designed to deliver approximately 100 Watts on an orbit-average basis, near the end of its expected life while in a worst-case orbit.

The following sections briefly describe the satellite's principal subsystems.

## 4.4.1 Communication Payload

The communication subsystem is the principal payload flown on the satellite. This subsystem consists of four major parts: the subscriber communications section, the ORBCOMM Gateway communications section, the satellite network computer, and the UHF transmitter.

### 4.4.1.1 SUBSCRIBER COMMUNICATIONS SECTION

The subscriber communications section consists of one subscriber transmitter, seven identical receivers, and the associated receive and transmit filters and antennas. Six of the receivers are used as subscriber receivers and the seventh is used as the DCAAS receiver. The subscriber transmitter is designed to transmit an operational output power of up to approximately 40 Watts, although the output is less during normal operation. The power of each transmitter can be varied over a 5 dB range, in 1 dB steps, to compensate for aging and other lifetime degradations. The subscriber transmitter power is controlled to maintain a maximum power flux density (PFD) on the surface of the Earth of slightly less than -125 dB (W/m<sup>2</sup> in 4 kHz). The output transmitter receives downlink packets from the satellite network computer, modulates and amplifies the signal and feeds it to the antenna subsystem. Symmetric Differential Phase Shift Keying (SDPSK) modulation is used on the subscriber downlink, at a data rate of 4800 bps. (It is capable of transmitting at 9600 bps.) SDPSK is defined by a “zero” (“space”) data state causing a negative 90° phase shift and the “one” (“mark”) data state causing a positive 90° phase shift. Raised cosine filtering is used to limit spectral occupancy.

Subscriber receivers are direct conversion digital signal processor (DSP)-driven receivers incorporating a fast fourier conversion process. The satellite can be configured to have any combination of the seven subscriber receivers act as the DCAAS, random access, or reservation receivers. Each receiver, when selected for DCAAS operation, is designed to scan the uplink band in 2.5 kHz steps in 5 seconds or less. The actual portion(s) of the receiver frequency band used in the DCAAS process depends on which GCC is connected to the satellite. The remaining subscriber receivers are used to process subscriber uplink traffic. The subscriber receivers and the Gateway receiver operate through a single uplink antenna. The low-noise amplifier (LNA) associated with SC receivers has been designed to operate linearly in the presence of high levels of interference. Analog and digital filters process the signals after the LNA to reduce the impact of interference due to terrestrial mobile systems on the subscriber receivers. Once received, the subscriber signals are demodulated and routed to the satellite network computer. The uplink modulation is SDPSK, with a data rate of 2400-bps. Raised cosine filtering is used to limit spectral occupancy.

### 4.4.1.2 ORBCOMM GATEWAY COMMUNICATIONS SECTION

Both the ORBCOMM Gateway satellite transmitter and receiver are contained in a single package. Separate right-hand circularly polarized (RHCP) antennas are used for the transmit and receive functions. The ORBCOMM Gateway transmitter is designed to transmit 5 Watts of RF power. The 57.6 kbps downlink signal to the GES is transmitted using an Offset Quadrature Phase Shift Keying (OQPSK) modulation in a TDMA format.

The satellite gateway receiver is designed to demodulate a 57.6 kbps TDMA signal with an OQPSK modulation. The received packets are routed to the onboard satellite network computer.

#### 4.4.1.3 SATELLITE NETWORK COMPUTER

Functionally, the satellite network computer receives the uplinked packets from the subscriber and ORBCOMM Gateway receivers and distributes them to the appropriate transmitter. The computer also identifies clear uplink channels via the DCAAS receiver and algorithm, and interfaces with the GPS receiver to extract information pertinent to the communications system. Several microprocessors in a distributed computer system aboard the satellite perform the satellite network computer functions.

#### 4.4.1.4 UHF TRANSMITTER

The UHF transmitter is a specially constructed 1-Watt transmitter that is designed to emit a highly stable signal at 400.1 MHz. The transmitter is coupled to a UHF antenna designed to have a peak gain of approximately 2 dB.

### 4.4.2 Antenna Pattern

The antenna subsystem consists of a deployable boom containing three separate circularly polarized quadrifiler antenna elements. The satellite antenna patterns are shown in Figure 4.3.

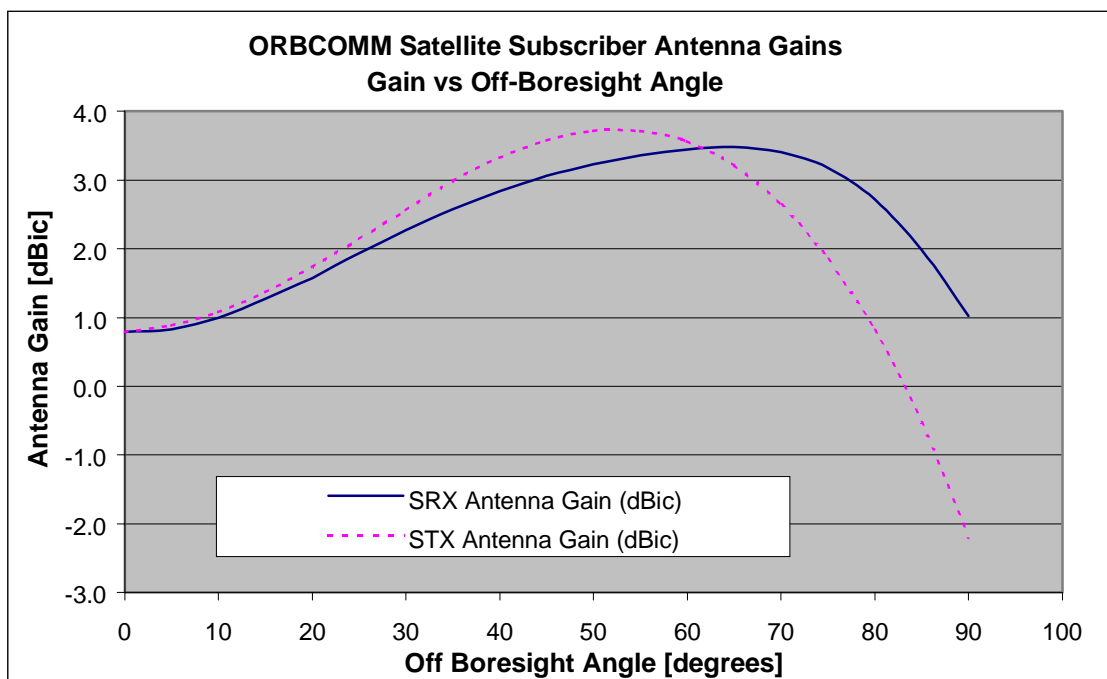

Figure 4.3 - Satellite Subscriber Antenna Gain Patterns

The necessary RF power splitters, phase shifters, and impedance matching transformers required to feed the various antenna elements are mounted internally in the deployable boom. In the launch configuration, the antenna is folded into a trough measuring approximately 15 x 15 x 97 cm (6 x 6 x 38 inches). After the solar arrays are released, the antenna is deployed. The antenna support structure is a series of four boom segments hinged at the ends. In addition to supporting the antenna, the support structure is also used as a mounting point for a three-axis magnetometer used by the satellite attitude control system (ACS).

### 4.4.3 Attitude Control System

The satellite ACS is designed to maintain both nadir and solar pointing. The satellite must maintain nadir pointing to keep the antenna subsystem oriented toward the Earth. Solar pointing maximizes the amount of power collected by the solar cells. The ACS subsystem employs a three-axis magnetic control system that operates with a combination of sensors. The satellite also obtains knowledge of its position through its on-board GPS receiver.

Satellite planes A, B, and C are designed such that the satellites maintain a separation of  $45^\circ$  ( $\pm 5^\circ$ ) from other satellites in the same orbital plane. Planes D and E are designed for a  $51.4^\circ$  spacing. The supplementary, highly inclined satellite planes (F and G) are designed such that the satellites are spaced  $180^\circ$  apart ( $\pm 5^\circ$ ). The springs used to release the satellites from the launch vehicle give them their initial separation velocity. A pressurized gas system will be used to perform braking maneuvers when the required relative in-orbit satellite spacing is achieved. An Orbital Sciences Corporation proprietary formation-keeping technique will maintain the specified satellite intra-plane spacing. One of the benefits of this technique is that, unlike geostationary satellites, it does not affect the satellite life expectancy in fuel usage.

# Chapter 5 SATELLITE CONNECTION MANAGEMENT

As satellites pass overhead, connections to SCs and GESs change dramatically. The GCC constantly makes and breaks links between the GESs and the satellites. Even the SC switches satellites to maintain communications with a particular Gateway.

Figure 5.1 shows the ORBCOMM System protocol stack. Note from the diagram that neither the GES nor the satellite makes network-level decisions. Only the GCC and SC are aware of the dynamic topology of the system.

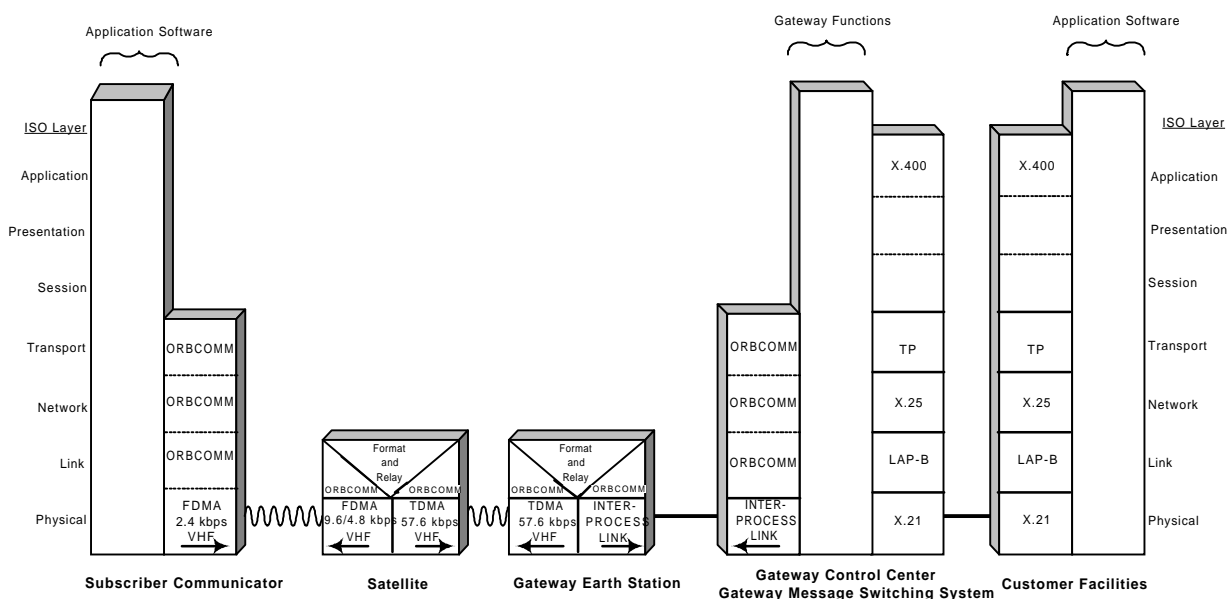

Figure 5.1 - Relationship of ORBCOMM Protocol Stack to Satellite Connections

## 5.1 Satellite-GES Connections

### 5.1.1 Establishing Connections

As a satellite travels over the GCC's service area, the GCC notifies the next GES in the satellite's connection schedule to begin tracking the satellite. This causes the next GES to pre-position the antenna at the proper azimuth and at a minimum elevation. This next GES passively receives the satellite's transmissions as the satellite rises above the horizon. At the minimum link establishment elevation (usually set to 5°), the GCC commands the current GES to release the link and the next GES to establish a link. After a link is established, the GCC redirects SC packets along the new route using the second GES.

Several GCCs can communicate with one satellite. No more than one GES may be used by a GCC to connect to a single satellite. On the GES-to-satellite uplink, different GES sites use different uplink TDMA time slots.

On the satellite-to-GES downlink, the satellite multiplexes downlink streams among the various GES sites. There is one satellite-to-GES downlink frequency used worldwide: 137.56 MHz.

Several satellites can be within the geometrical line of sight of a GES. Within a GCC's service area, all satellites use the same satellite-to-GES downlink frequency. The GES's narrow beamwidth antenna is used to discriminate among several satellite downlinks.

### **5.1.2 Satellite Selection Process**

The Satellite Selection Process (SSP) controls the connection and disconnection of GES-satellite links. If there are multiple GES sites per GCC and there are multiple satellites in view, optimizing these links for best performance presents a difficult scheduling problem. The SSP scheduling algorithm is designed to maximize availability and capacity over a given service region. The scheduling algorithm considers GES site locations, satellite locations as a function of time, subsystem failures, and degraded GES-satellite links. A 24-hour schedule is generated for link connections for the entire service area. The schedule can be overridden at any time by GCC operator commands.

The Gateway service area is defined as the sum of satellite footprint areas where the GESs and satellite can be connected to one other. Each GES has a connection radius of approximately 3100 km.

## **5.2 SC Networking**

An SC is capable of switching among satellite downlinks in order to locate the destination Gateway of queued messages and reports. This is accomplished by listening for the Gateway Information packet. This packet displays the IDs of all connected Gateways and is downlinked from the satellite every 4 seconds (nominally).

When messages are queued within an SC, the SC searches for satellites showing active connections to the messages' destination Gateways. With no messages queued, there are configurable rules within the SC which dictate whether an SC maintains lock with the current satellite or whether it continues to search. The most common option is to maintain lock with a satellite having a connection to the desired Gateway (also configurable).

The SC has no knowledge of a satellite hand-off event from one GES to the next. The Gateway Information packet displays the Gateway ID, not the GES ID.

If the satellite sets during a message session, the SC attempts to locate another satellite with a connection to the same Gateway. The message session then proceeds through the new satellite. No acknowledged data packets are retransmitted.

# Appendix A DATA SESSION DESCRIPTIONS

## A.1 Introduction

This appendix describes the data/channel handshaking and packet transmission exchanges that occur between Subscriber Communicators (SCs), satellites, and gateways. These data transfer sequences occur when an SC and the satellite constellation operate in conjunction with an ORBCOMM Gateway to deliver the four basic ORBCOMM message types: Data Reports, Messages, Commands, and GlobalGrams. See Section 2.2 for a description of the ORBCOMM basic service elements.

## A.2 Data Session Setup

Once power is applied to an SC, its radio frequency (RF) receiver automatically searches for a satellite signal using an internally stored list of satellite downlink channels. If the SC has not locked on a signal since power was applied and it does not detect a satellite signal at any of its stored channels, it searches for a satellite signal in all possible channels in the 137-138 MHz satellite-to-subscriber band. If the SC still does not find a downlink signal, it reverts to a reduced power (sleep) mode for a predefined time interval, then re-attempts the search process.

A satellite signal detected by the SC contains the control information necessary to begin a data transfer session. This control information includes timing information, a list of the connected ORBCOMM Gateways, and a list of the current uplink random access channels. (This list of available channels changes frequently according to the Dynamic Channel Activity Assignment System (DCAAS) process.) The satellite retransmits this information approximately every 8 seconds.

## A.3 SC-Originated Message Transfer

If an SC-Originated message is stored in an SC's message queue, the SC-Originated data transfer session begins with a data setup and transfer process called the Acquire/Communicate (A/C) process.

### A.3.1 Acquire/Communicate

The A/C process consists of two steps:

1. Once the SC receives the control information signal from the satellite, it responds by sending a "request to send" signal to the satellite.

The satellite should receive the burst correctly if there is no interference and there are no time-overlapping bursts on the same receive channel. The satellite responds with control information specific to that SC. The SC waits a specific time period to receive this control information from the satellite. If the SC does not receive the control information, the process is repeated at a later time.



2. The second step begins after the SC receives the specific control information. The SC transmits a short communicate burst to the satellite that can contain a Data Report (up to 6 bytes of user defined data), a request to send a larger amount of data (a “Message”), or control information.

### **A.3.2 Longer Message Transfer (Messages)**

If the communicate burst from an SC contains a request to send a larger amount of data (a Message), the Gateway Message Switching System (GMSS) of the addressed ORBCOMM Gateway responds with an assignment packet that contains the number and length of packets needed to transmit the message. The satellite selects a reserved time slot and an uplink frequency channel and transmits the information to the SC to complete the assignment. The SC sends each Message burst to a satellite receiver configured for message reception.

After each Message burst is sent, the SC waits to receive an acknowledgment from the GMSS. If the SC receives an acknowledgment from the GMSS that contains an assignment to send packets, it sends a Message burst at the assigned time and on the assigned uplink channel. This process repeats until the message is completely and successfully transferred from the SC to the GMSS.

The protocol is designed to be very robust. There is an automatic recovery from events such as packets being received incorrectly or satellites moving out of view. In fact, some message packets may be transferred over one ORBCOMM satellite and some packets over another ORBCOMM satellite. The GMSS puts the message together and transfers the complete message. Figure A-1 is a graphical representation of the data session process.

## **A.4 SC-Terminated Message Transfer**

If an ORBCOMM Gateway has a message addressed to an SC, it first sends an assignment packet to the appropriate satellite, which transmits the assignment packet to the SC.

In response to an assignment packet, the SC sends a “ready to receive” packet. The ORBCOMM Gateway will then start forwarding message packets to the SC. The transfer is complete after the SC acknowledges the final packet. Figure A.2 shows the process for SC-Terminated message transfer.

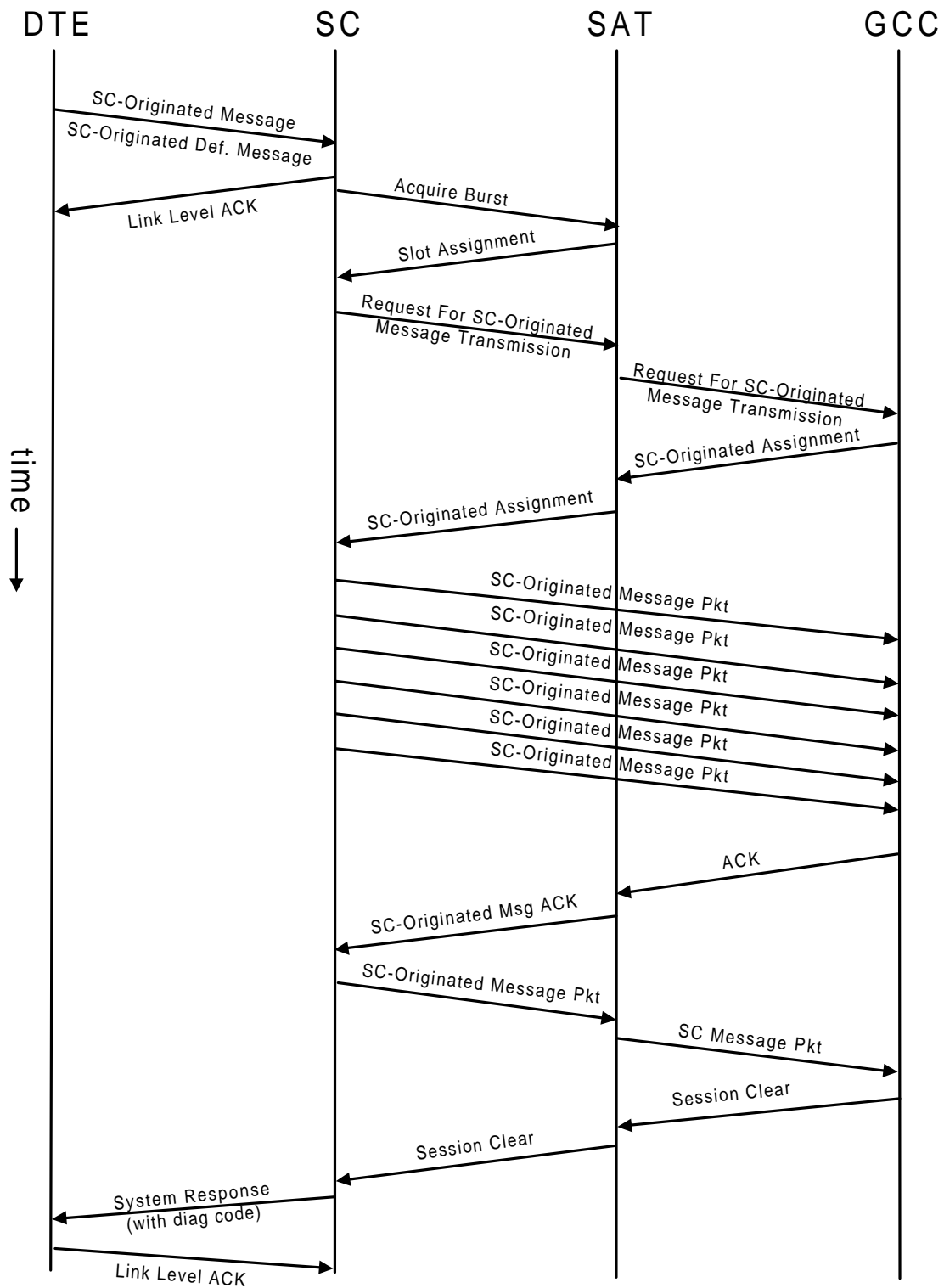

Figure A.1 - SC-Originated Message Transfer Session

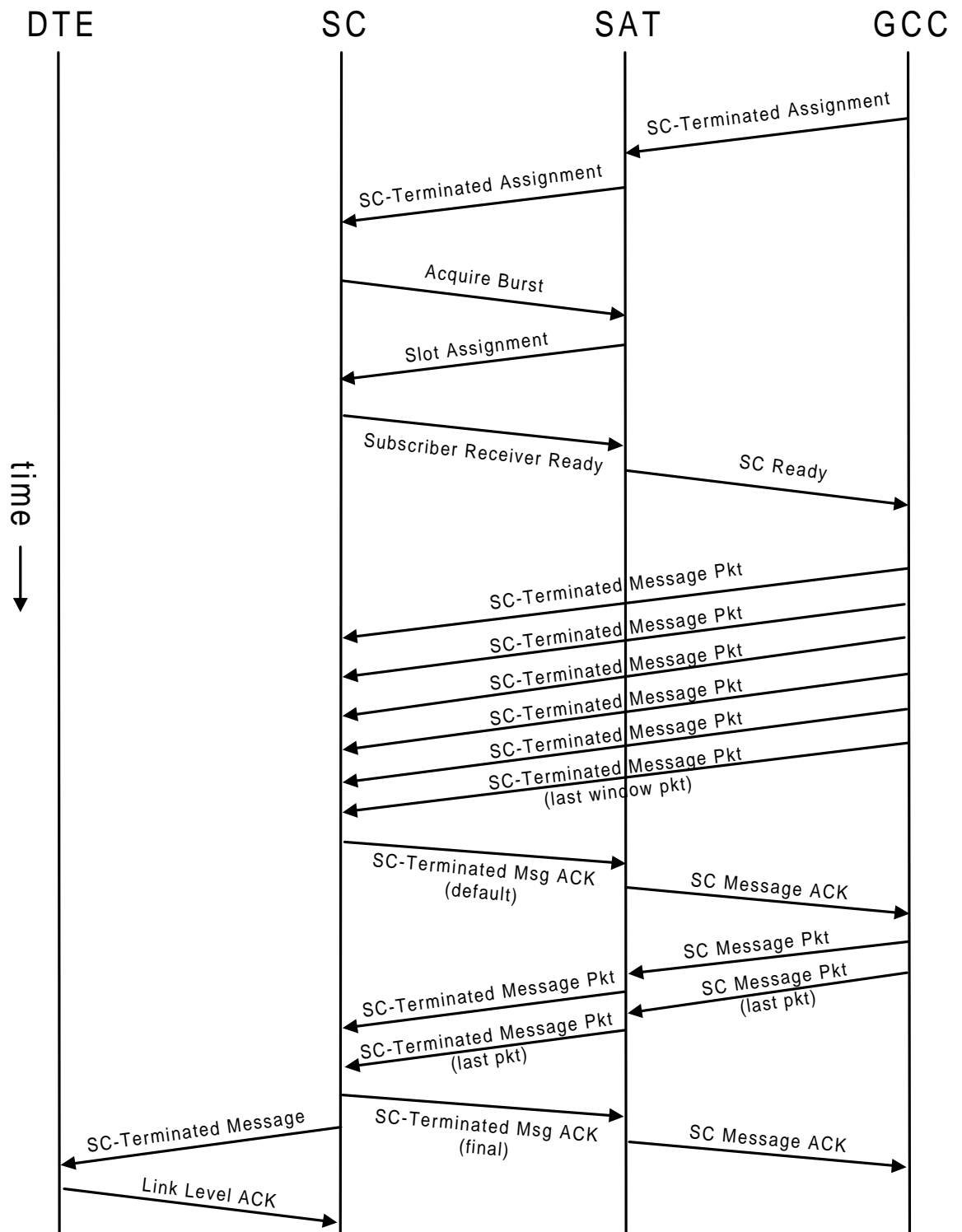

Figure A.2 – SC - Terminated Message Transfer Session

## A.5 GlobalGrams

GlobalGram messaging, or store and forward message transfer, is available in instances when a satellite is in view of an SC, but there are no ORBCOMM Gateways connected to the satellite. Cases are expected to include ocean areas and locations where there is no Gateway, but regulatory approval for an SC to communicate with a satellite has been granted. GlobalGrams allow satellites and SCs to archive short messages when the destination ORBCOMM Gateway is inaccessible by the satellite constellation. The stored messages are transmitted when an ORBCOMM Gateway comes into satellite-transmission range.

### A.5.1 SC-Originated GlobalGrams

For an SC-Originated (SC-to-ORBCOMM Gateway) GlobalGram, the SC uses the normal A/C protocol and sends a request packet to the satellite. The satellite responds with an assignment packet whereby the SC sends the GlobalGram on the assigned frequency. The satellite will reserve sufficient time for the transmission of the number of bytes indicated in the request packet. The satellite responds with a GlobalGram acknowledgment packet. The SC will automatically retransmit the request if it does not receive an assignment or an acknowledgment. The satellite stores the GlobalGram packet in a memory queue until the destination ORBCOMM Gateway can connect to that satellite.

### A.5.2 SC-Terminated GlobalGrams

For an SC-Terminated (ORBCOMM Gateway-to-SC) GlobalGram, the message is sent over the terrestrial connection to an ORBCOMM Gateway. The GlobalGrams are then sent to a satellite and stored in the satellite memory.

## A.6 SC-to-SC Messaging

All communications from one SC to another are routed through a Gateway. SC-to-SC messages cannot be transmitted over a satellite without going through the GMSS and billing system. The following combinations of service types are possible:

- SC-Originated Message to SC-Terminated Message;
- Data report to SC-Terminated Message;
- Subscriber-Originated GlobalGram to Subscriber-Terminated GlobalGram; and
- SC-Originated Message to SC-Terminated GlobalGram.

## Appendix B ORBCOMM CONSTELLATION ORBITAL PARAMETERS

Table B.1 provides a list of target orbital parameters for the 47 Satellites of the licensed constellation.

<b>Plane designation</b>	A, B, C, D	F	G	E
<b>Number of orbital planes</b>	4	1	1	1
<b>Number of satellites in each orbital plane</b>	8	4	4	7
<b>Right ascension of the ascending nodes</b>	0, 90, 180, 270	0	0	0
<b>Inclination angle</b>	45	70	108	0
<b>Initial phase angle</b>	0, 45, 90, 135, 180, 225, 270, 315	0, 90, 180, 270	0, 90, 180, 270	0, 51.4, 102.8, 154.3, 205.7, 257.1, 308.6
<b>Semi-major axis (km)</b>	7203	7153	7208	7378
<b>Eccentricity</b>	0.0	0.0	0.0	0.0
<b>Argument of perigee</b>	0.0	0.0	0.0	0.0

**Table B.1 - Constellation Orbital Parameters**

# Appendix C ORBCOMM LINK BUDGET PARAMETERS

## C.1 Introduction

The following are the edge-of-coverage operating link budgets for the ORBCOMM System. The satellites do not use turn-around transponders; all received packets are demodulated and remodulated prior to transmission.

The link budgets that follow are calculated under a number of worst case assumptions. The actual instantaneous link margins for the various communication paths will depend on the satellite/subscriber or satellite/Gateway Earth Station (GES) geometry, local blockage, multipath, and a number of other factors. The geometry represented by the link budgets presented below is for the satellite as seen at a 5° elevation angle. The corresponding off-boresight angle at the satellite for an 825-km (512-mile) altitude orbit is approximately 62° off-nadir. More importantly, the table data include reasonable margins for expected propagation conditions, polarization losses, and obtainable hardware implementations, while the resulting link data indicate positive margins.

## C.2 GES-to-Satellite Link Budget

The GES/satellite communications link is supported by Earth-station Effective Isotropic Radiated Power (EIRP) of 40-dBW. The ratio of antenna gain to receiver noise temperature (G/T) used in the link budget is reduced by approximately 0.9 dB to account for an expected antenna temperature above 290° K, caused by the sky noise in the very high frequency (VHF) range.

The GES uplink signal is approximately 50 kHz wide. Most of the terrestrial mobile systems worldwide are channelized on 25-kHz centers. This channelization means that the satellite/Gateway receiver will operate in the presence of unwanted signals from at least two terrestrial mobile channels. The link budget includes an interference margin to account for this interference. Table C.1 shows the GES/satellite uplink budget.

<b>(Edge of Coverage, Minimum Elevation)</b>			
<b>General Information</b>	<b>Value</b>	<b>Units</b>	<b>Comments</b>
Satellite Altitude	825	km	
Elevation Angle to Satellite	5	degrees	
Satellite Angle from Nadir	62	degrees	
Range to Earth	2837	km	
Data Rate	57,600	bps	
Uplink Frequency	149.4	MHz	
Uplink			
Transmit EIRP	33	dBW	
Spreading Loss	-140.1	dBm <sup>2</sup>	
Pointing Loss	0.3	dB	
Atmospheric Losses	0.2	dB	
Polarization Losses	0.1	dB	GES Axial ratio = 1.2 dB, SC = 2.0 dB
Multipath Fade Losses	5.0	dB	
Area of an Isotrope	-4.9	dBm <sup>2</sup>	
Power @ Satellite Antenna	-117.6	dBW	
Satellite Antenna G/T	-32.4	db/°K	
Received C/No	78.6	dBHz	
Data Rate	47.6	dBHz	57.6 kbps
Received Eb/No	31.0	dB	
Ideal Eb/No	10.6	dB	OQPSK BER @ 1x10 <sup>-6</sup>
Implementation Loss	2.0	dB	
Command Margin	5.0	dB	
Interference Margin	10.0	dB	
Remaining Margin	3.4	dB	

**Table C.1 - ORBCOMM GES-to-Satellite Uplink Budget**

### C.3 Satellite-to-Subscriber Link Budget

The satellite-to-subscriber link budget, presented in Table C.2, is based on a Subscriber Communicator (SC) that uses an omni-directional antenna with 0 dB gain and a 2 dB noise figure. The losses between the antennas and low-noise amplifiers (LNA) are assumed to be approximately 0.7 dB. A degradation allowance is included for a sky temperature higher than 290° K. Due to changes in orbital parameters, the actual satellite transmit power may be changed slightly in order to meet a maximum power flux density (PFD) threshold limit of -125 dB(W/m<sup>2</sup> in 4 kHz).

<b>(Edge of Coverage, Minimum Elevation)</b>			
<b>General Information</b>	<b>Value</b>	<b>Units</b>	<b>Comments</b>
Satellite Altitude	825	km	
User Elevation Angle	5	degrees	
User Data Rate	4800	bps	
Downlink Frequency	137.5	MHz	
Down Link			
Transmit EIRP	12.0	dBW	
Spreading Loss	-140.1	dBm <sup>2</sup>	
Atmospheric Losses	0.2	dB	
Polarization Losses	4.1	dB	S/C 2 dB axial ratio, subscriber linear
Multipath Fade Losses	5.0	dB	
Satellite Pointing Loss	0.3	dB	5 degree off-nadir pointing
Area of an Isotrope	-4.2	dBm <sup>2</sup>	
Power @ User Antenna	-141.9	dBW	
Subscriber Antenna G/T	-28.6	dB/°K	
Received C/No	58.1	dBHz	
Data Rate	36.8	dBHz	4.8 kbps
Received Eb/No	21.3	dB	
Ideal Eb/No	10.3	dB	SDPSK BER @ 10 <sup>-5</sup>
Implementation Margin	3.0	dB	
Interference Margin	4.0	dB	
Required Link Margin	3.0	dB	
Remaining Margin	1.0	dB	

**Table C.2 - Satellite-to-Subscriber Link Budget**



## C.4 Subscriber-to-Satellite Link Budget

The subscriber-to-satellite link budget, presented in Table C.3, is based on an SC EIRP of 7.5 dBW. This EIRP is available from a 5-Watt transmitter and a whip antenna having 0 dB gain.

<b>(Edge of Coverage, Minimum Elevation)</b>			
<b>General Information</b>	<b>Value</b>	<b>Units</b>	<b>Comments</b>
Satellite Altitude	825	km	
User Elevation Angle	5	Deg	
User Data Rate	2400	bps	
Uplink Frequency	149	MHz	
<b>Uplink</b>			
Transmit EIRP	7.5	dBW	
Spreading Loss	-140.1	dBm <sup>2</sup>	
Atmospheric Losses	0.2	dB	
Polarization Losses	4.1	dB	S/C 2 dB axial ratio, subscriber linear
Multipath Fade Losses	5.0	dB	
Satellite Pointing Loss	0.3	dB	5 degree off-nadir pointing
Area of an Isotrope	-4.9	dBm <sup>2</sup>	
Power @ Satellite Antenna	-148.5	dBW	
Satellite G/T	-29.0	dB	
Received Pr/No	52.5	dBHz	
Data Rate	33.8	dBHz	2.4 kbps
Received Eb/No	18.7	dB	
Ideal Eb/No	10.3	dB	SDPSK BER @ 10 <sup>-5</sup>
Implementation Loss	3.0	dB	
Required Link Margin	3.0	dB	
Remaining Margin	2.4	dB	

**Table C.3 - Subscriber-to-Satellite Link Budget**

## C.5 Satellite-to-Gateway Link Budget

The satellite-to-gateway link budget, presented in Table C.4, is based on a satellite EIRP of 1.3 dBW, at 62° from nadir. A degradation allowance of 2 dB has been taken to account for sky temperatures above 290° K.

<b>(Edge of Coverage, Minimum Elevation)</b>			
<b>General Information</b>	<b>Value</b>	<b>Units</b>	<b>Comments</b>
Satellite Altitude	825	km	
GES Elevation Angle to Satellite	5	Deg	
Data Rate	57,600	bps	
<b>Downlink Frequency</b>	137.56	MHz	
Down Link Budget			
Transmit EIRP	1.3	dBW	
Spreading Loss	-140.1	dBm <sup>2</sup>	
Pointing Loss	0.3	dB	5 degree off-nadir pointing
Atmospheric Losses	0.2	dB	
Polarization Losses	0.4	dB	S/C 4 dB axial ratio, GES 1.2 dB
Multipath Fade Losses	5.0	dB	
Area of an Isotrope	-4.2	dBm <sup>2</sup>	
Power @ Satellite Antenna	-144.8	dBW	
Gateway Antenna G/T	-14.0	db/°K	
Received C/No	65.8	dBHz	
Data Rate	47.6	dBHz	57.6 kbps
Received Eb/No	18.2	dB	
Ideal Eb/No	10.6	dB	OQPSK BER @ 1x10 <sup>-6</sup>
Implementation Loss	2.7	dB	
Required Link Margin	3.0	dB	
Remaining Margin	1.9	-dB	

**Table C.4 - Satellite-to-Gateway Link Budget**

## C.6 UHF Transmitter Link Budget

The ultra high frequency (UHF) downlink link budget is presented in Table C.5. The link budget is based on an omni-directional SC with a noise figure of 3 dB at 400.1 MHz. The satellite EIRP is made up of a gain of 3.2 dBi, 62.5° from nadir; a high power amplifier (HPA)-to-antenna loss of approximately 0.7 dB; and an HPA operational output of 0 dBW.

<b>(Edge of Coverage, Minimum Elevation)</b>			
<b>General Information</b>	<b>Value</b>	<b>Units</b>	<b>Comments</b>
Satellite Altitude	825	km	
User Elevation Angle	5.0	degrees	
Downlink Frequency	400.1	MHz	
Downlink	825	km	
Transmit EIRP	1.0	dBW	
Spreading Loss	-140.1	dBm <sup>2</sup>	
Atmospheric Losses	0.3	dB	
Polarization Losses	4.1	dB	S/C 2 dB axial ratio, subscriber linear
Multipath Fade Losses	4.0	dB	
Area of an Isotrope	-13.9	dBm <sup>2</sup>	
Receiver Gain	0.0	dBi	
Antenna-to-Receiver Losses	-1.0	dB	
Received Signal Level	-162.0	dBW	
Receiver Noise Temp.	24.6	dB°K	3 dB noise figure
Receiver Loop Bandwidth	20.0	dBHz	
Boltzmann's Constant	-228.6	dBW/Hz°K	
Receiver Noise Power	-184.0	dBW	
Received Signal-to-Noise	22.0	dB	

**Table C.5 - UHF-to-Subscriber Downlink Budget**

## Appendix D SATELLITE FREQUENCY & POLARIZATION PLAN

Table D.1 and Table D.2 list the channels specifically requested for the ORBCOMM System. The 137-MHz frequency plan is presented in Table D.1. As explained in detail in *Appendix E, Frequency Sharing Aspect of the ORBCOMM System*, this frequency plan (in addition to the International coordination efforts) should ensure that meteorological satellites and other space science services operating in the 137.0-138.0 MHz band receive no interference from the ORBCOMM System downlinks.

Channel No.	Channel Freq. (MHz)	Channel Bandwidth (kHz)	Data rate (kbps)	Polarization
S-1	137.2000	25	9.6/4.8	RHCP
S-2	137.2250	25	9.6/4.8	RHCP
S-3	137.2500	25	9.6/4.8	RHCP
S-4	137.4400	25	9.6/4.8	RHCP
S-5	137.4600	25	9.6/4.8	RHCP
S-6	137.6625	25	9.6/4.8	RHCP
S-7	137.6875	25	9.6/4.8	RHCP
S-8	137.7125	25	9.6/4.8	RHCP
S-9	137.7375	25	9.6/4.8	RHCP
S-10	137.8000	25	9.6/4.8	RHCP
S-11	137.2875	25	9.6/4.8	RHCP
S-12	137.3125	25	9.6/4.8	RHCP
Gateway	137.5600	50	57.6	RHCP

**Table D.1 - 137.0-138.0 MHz Downlink Channelization and Polarization Plan**

Table D.2 shows the ORBCOMM System uplink frequency and polarization plan in the 149-150.05 MHz band (U.S. Only).

Channel	Lower Band Edge (MHz)	Upper Band Edge (MHz)	Center Freq. (MHz)	Bandwidth (kHz)	Polarization <sup>1</sup>	Comment
1	149.585	149.635	149.610	50	RHCP	U.S. GES Uplink
1a	149.900	150.05		150		Will not be used for Subscriber Communicators
2	148.005	149.895	Dynamic <sup>2</sup>	10	RHCP	760 uplink DCAAS Subscriber channels

**Table D.2 - 148-150.05 MHz Uplink Channelization and Polarization Plan**

<sup>1</sup> Satellite receive polarization is right hand circularly polarized (RHCP).

<sup>2</sup> The Dynamic Channel Activity Assignment System (DCAAS) will operate within the 148-149.9 MHz band, autonomously selecting unused channels.

## Appendix E FREQUENCY SHARING ASPECT OF THE ORBCOMM SYSTEM

Known systems operating in or near the Mobile Satellite Service (MSS) operational bands include the following:

- aeronautical mobile systems operating below 137 MHz;
- space science systems, such as the U.S., German, and Russian meteorological satellite (MetSat) systems that downlink in the 137-138 MHz band;
- terrestrial fixed and mobile systems operating in the 148-149.9 MHz band;
- Russian radio navigation satellite system operating in the 149.9-150.05 MHz band;
- Radio astronomy systems operating at various nearby frequencies; and
- other potential mobile satellite services.

The ORBCOMM System is designed to avoid interfering with all of these systems. Interference analysis addressing each of the systems is provided below.

### E.1 137-138 MHz Space-to-Earth Frequency Band

#### E.1.1 Satellite Power Flux Density Threshold Limit

The MSS downlink transmissions in the 137-138 MHz band are constrained to operate either with a power flux density (PFD) value of  $-125$  dB ( $W/m^2$  in 4 kHz), or to coordinate with terrestrial fixed and mobile users in the band. The ORBCOMM System operates within this PFD threshold. Because the ORBCOMM satellites operate within this PFD limit, no coordination is necessary with terrestrial fixed and mobile systems operating in the 137-138 MHz band. This PFD threshold limit is different for MSS systems supplying Appendix C information to the International Telecommunications Union (ITU) after 1 November 1996. The ORBCOMM Appendix C information was submitted to the ITU prior to this date under the name LEOTELCOM-1.

#### E.1.2 Frequency Sharing with Incumbent Users

The 137-138 MHz band used by ORBCOMM for downlinks is also used by fixed and mobile systems in some countries, as well as by MetSats and other MSS systems similar to ORBCOMM. ORBCOMM satellite emissions meet the PFD threshold contained in the ITU Radiocommunication Sector (ITU-R) *Radio Regulations* to protect the fixed and mobile services.

ORBCOMM has closely coordinated with the U.S. National Oceanic and Atmospheric Administration (NOAA) to ensure that U.S. and European MetSat operations are protected. ORBCOMM has also coordinated with Russia for protection of their MetSats.

### **E.1.3 Frequency Sharing with New Users**

New MSS systems must be coordinated with ORBCOMM before they can be brought into operation.

## **E.2 148-149.9 MHz Earth-to-Space Frequency Band**

The 148.0-149.9 MHz uplink band is heavily used by terrestrial systems. These are generally push-to-talk mobile radio systems, but also include some digital mobile systems, pager transmitters, and repeaters. To avoid receiving interference from these systems, as well as to avoid interfering with these systems, ORBCOMM has developed an approach to radio frequency (RF) compatibility consisting of four levels:

- The Dynamic Channel Activity Assignment System (DCAAS) avoids assigning active mobile channels (with Effective Isotropic Radiated Power (EIRP) toward the satellite greater than approximately 0.1 W in 3 kHz) to Mobile Earth Stations (MESs) for uplink transmissions. The system scans the frequency band for inactive channels approximately every 5 seconds. The DCAAS system will not permit the MESs to transmit if there are no inactive channels available.
- Should the DCAAS system inadvertently assign an active channel, there is a very low probability that a transmitting MES is sufficiently close to a receiving mobile unit to be detected.
- The short burst duration of ORBCOMM MES transmissions further minimizes any interference effects.
- The structure of the SC message transmission session is such that even if interference does occur, it will not continue or re-occur.

More detailed descriptions of each of these aspects of ORBCOMM's approach to RF compatibility are provided in the following sections.

### **E.2.1 Level 1 - DCAAS**

The first level of the ORBCOMM uplink interference avoidance approach is DCAAS, which consists of a receiver and processing unit on the satellites. DCAAS, using an onboard spectrum analyzer, scans the uplink band for terrestrial transmissions using a resolution bandwidth of 2.5 kHz. It identifies channels that are not in use and assigns those channels for uplink use by the MESs. The objective is to avoid interfering with terrestrial receivers by preventing ORBCOMM subscriber transmissions on active mobile channels.

It is important to note the following:

- An ORBCOMM MES can transmit only if it first receives a downlink signal from the ORBCOMM satellite telling it which uplink channels may be used.
- If the DCAAS system cannot find an inactive channel at a particular point in time, DCAAS will not permit the MESs to transmit. Any attempt by the satellite to receive on a channel being actively used by a terrestrial transmitter would result in interference to the satellite and the loss of MSS data.

In addition to scanning for inactive channels, the DCAAS processor predicts which of the available channels are most likely to be available for the next 5 seconds. Figure E.1 is a graphical representation of the various factors that affect the channel selection and implementation process described below.

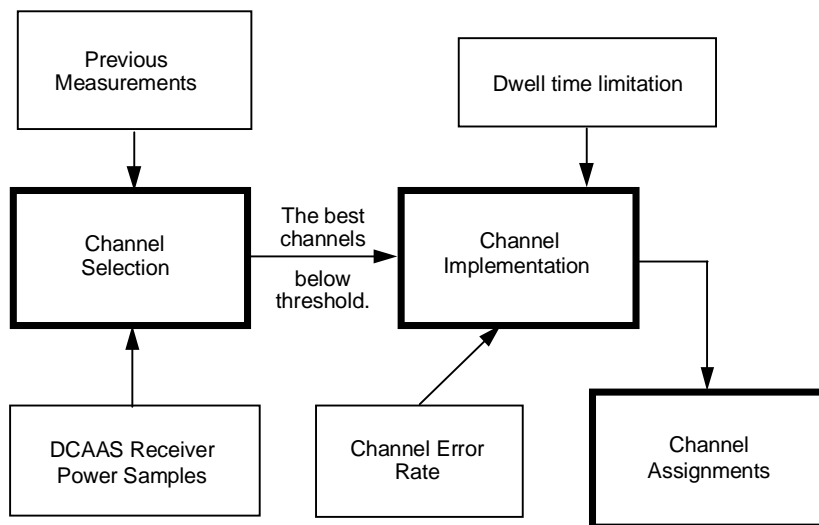

**Figure E.1 - DCAAS Operation**

### E.2.1.1 Channel Selection

There are two inputs to the algorithm that identifies the preferred channels available on each scan:

- **Power Sampling.** One satellite receiver operates in DCAAS mode and scans all channels in the selected operating range. Channels for which the power samples fall below a specific threshold are declared to be potentially available. The power sample threshold determination is a strict decision and thus carries the highest weight of the channel selection criteria.
- **Quality Factor.** This criterion considers power sample measurements made over the previous 5 seconds. The quality factor is a measure of the current and past power levels of the channel, as determined by an ORBCOMM-proprietary algorithm.

Once all factors are considered, the preferred channels are selected from the available channels and passed to the channel implementation portion of the algorithm.

### E.2.1.2 Channel Implementation

Once the channel selection process determines the preferred channel frequencies, the channel implementation process assigns these channels for random access (acquire/communicate transmissions) and reservation channel (messaging transmissions) use. The remaining channels are placed in a reserve pool. The reserve pool is used under the following conditions:

- when the performance measurement thresholds (error rates) of the receiver are exceeded;



- when the channel selection process using new DCAAS scan data shows that the power level exceeds the quality factor threshold on the currently assigned channel; or
- when a channel dwell-limiting timer expires for a random access receiver.

Under normal conditions of moderate to heavy traffic loading, the satellite will change the uplink channel to a different frequency in 1 to 2 seconds if the bit error rate threshold on that channel is exceeded. Under light traffic loading conditions, there may be insufficient uplink signals to evaluate the bit error rate, and so the channel frequency may not be changed until the next DCAAS scan is completed, within approximately 5 seconds plus a short processing time. During this time, however, there will be very few MES transmissions because the situation can only occur under very light traffic loading conditions.

DCAAS uses the data from the current scan to identify channels that appear to be inactive, then combines the information from the current scan with information from previous scans to make a prediction as to which of these available channels are likely to remain inactive.

### **E.2.1.3 Probability of DCAAS Assigning an Active Channel**

In some cases, the DCAAS receiver on the ORBCOMM satellite may not be able to see terrestrial mobile transmitters due to an obstruction (such as a building) along the Earth-to-space path between the mobile transmitter and the ORBCOMM satellite, or due to ground reflection losses for the terrestrial mobile. In addition, the DCAAS monitoring system may not detect short burst low duty cycle terrestrial data traffic. In this case, the DCAAS receiver might not sense the mobile transmitter, and therefore might assign that active channel to an MES transmitter.

The probability of this occurring will vary depending on location and local topography. Att. 20 of ITU-R document WP8D/200 estimates this probability of obstruction to be 20 percent, based on this same rate of service inability for cellular phones in Japan. This would seem to be an upper bound on the probability since it applies to a terrestrial path, while the Earth-to-space path between the Mobile transmitter and the ORBCOMM satellite would have a minimum elevation angle of 5°.

The additional factors described below reduce the probability of DCAAS assigning an active channel but are difficult to quantify.

- If the frequency band is used heavily by the terrestrial mobile services employing frequency reuse, there is a high probability that a second mobile transmitter visible to the ORBCOMM satellite is also using that same channel, thereby preventing DCAAS from assigning that channel.
- If the Earth-to-space path from a mobile transmitter to an ORBCOMM satellite is blocked, there is a certain probability that the terrestrial path between the MES and the mobile receiver is also blocked. It can be expected that in areas where the probability of blockage on the Earth-to-space pass is highest, the probability of blockage on the terrestrial path is also high.

- If the Earth-to-space path from a mobile transmitter to an ORBCOMM satellite is blocked, there is a higher probability that the MES is also blocked from the satellite, reducing the probability that an MES could be transmitting in that area.
- The predictive algorithm in the DCAAS processor will evaluate the probability that its available channels will remain interference free until the next scan is complete. This takes into account data from recent scans, so that a channel used by a terrestrial mobile transmitter that suddenly vanishes behind an obstruction will probably not be assigned for use if other channels are available.

It would be extremely difficult to determine a single value that represents the probability that DCAAS will assign an active channel to an MES transmitter. The probability would change from one geographic area to another and would be affected by the level of frequency reuse by the terrestrial services as well as by the factors described above. ORBCOMM estimates the probability of DCAAS assigning an active channel to be considerably lower than the upper bound Japanese estimate.

### **E.2.2 Level 2 - Low Probability of Proximity**

As discussed above, it is possible that, due to obstructions, the DCAAS system would permit a subscriber to transmit on a channel that is being used by a terrestrial receiver. However, if this happens, there is a very low probability that the subscriber would be close enough for the terrestrial receiver to see the signal. The satellite antenna footprint is approximately 5,100 km in diameter. Since there are only six receivers on the ORBCOMM satellite, there can be no more than six simultaneous uplinks at a time and therefore only six SCs transmitting in this large footprint. For a terrestrial receiver to “see” the signal from an SC, they must be located relatively close to each other, on the order of tens of kilometers apart depending on the system characteristics. Comparing the 10-20 km circular area around a “victim” terrestrial receiver to the 5,100 km circular area of the satellite footprint indicates that the probability of the receiver seeing the SC is very small. Models for this are discussed in some detail in ITU-R Recommendation M.1039.

### **E.2.3 Level 3 - Short Duration Signals**

Even if DCAAS assigns a channel to an SC that is being used by a terrestrial system, and if that SC happens to be close to the terrestrial receiver using that frequency, the effect of the SC emissions on the receiver will be relatively small because the SC transmission bursts are relatively short. The maximum transmission burst length is 500 ms, but the most common bursts will be 60–100 ms. For many receiving systems, bursts of this length will not break the squelch circuit. ORBCOMM transmissions do not significantly affect the existing noisy RF environment in the band.

### **E.2.4 Level 4 - Signal Structure Reduces Interference**

The structure of an ORBCOMM data session will also tend to reduce interference. Once power is applied, the MES automatically searches through an internally stored list of downlink channels. If the MES has not locked onto a satellite signal since power was applied and there is no satellite signal on any of the stored channels, a search of all possible channels in the 137-138 MHz band is conducted.

Once a satellite signal is found it must be received continuously for 2 seconds to begin a data transfer session. During this time, the MES receives the necessary control information, which includes the timing, the ORBCOMM Gateways connected to the satellite, and the current uplink random access channels.

**NOTE:** The MES must receive this information before it can transmit data to the satellite.

Figure E.2 is a graphical representation of the data session process. A more detailed description is contained in Appendix A.

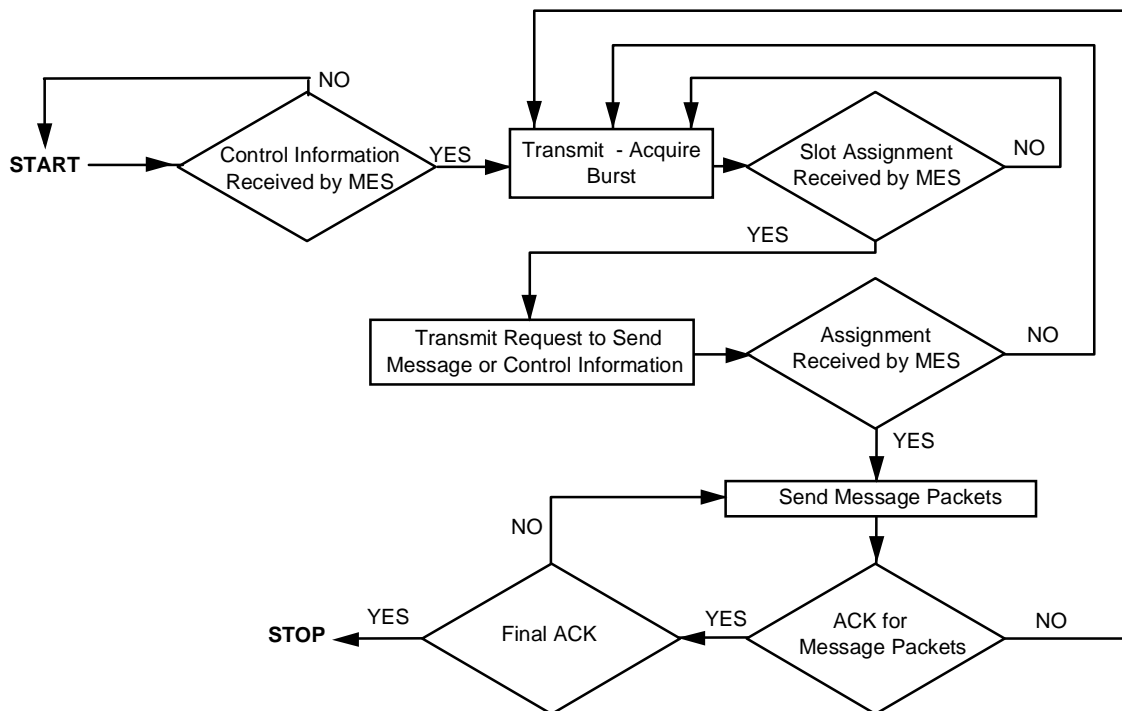

Figure E.2 - MES Data Transfer Session Flowchart

## E.3 Out-of-Band Sharing

### E.3.1 Radio Astronomy in the 150.05-153 & 406.1-410 MHz Bands

The radio astronomy service industry operates very sensitive radio telescopes in the 150.05-153 MHz and 406.1-410 MHz bands. The ORBCOMM satellites will operate three downlink transmitters: one subscriber transmitter and one ORBCOMM Gateway transmitter (both in the 137-138 MHz frequency band); and a beacon transmitter at 400.1 MHz. As Table E.1 shows, a number of factors provide the necessary isolation of ORBCOMM System transmitters from radio astronomy receivers. These factors include spectrum roll-off, diplexer or filter attenuation, and the path loss between the satellite and radio telescope. In some cases, the antenna response roll-off will provide additional isolation.

The satellite is designed to be very quiet in the 148-150.05 MHz uplink band. Therefore, it should be quiet in the neighboring 150.05-153 MHz radio astronomy (RA) band. The diplexer and filter isolations, shown in Table E.1, are minimum isolation values measured at 153 MHz. At other points between 150.05 and 153 MHz, the isolation is significantly greater.

**EXAMPLE:** The satellite receiver “in-band” response of the diplexer associated with the subscriber transmitter is greater than 70 dB from 148-150.05 MHz. In the region from 150.05-153 MHz, the isolation slopes from 70 dB to 30 dB.

The 400.1 MHz UHF carrier wave (CW) beacon transmitter is located near the 406.1-410 MHz RA band. This transmitter has been designed to have very good phase noise. Therefore, it is expected to have very good out-of-band response. The measured transmitter output, in the 406-410 MHz range, is greater than -130 dBc/MHz.

The received satellite power, as measured on the surface of the Earth, is a function of the satellite antenna pattern and the path loss from the satellite to the ground. Both of these factors vary as a function of the elevation angle at which the satellite is viewed. Table E.1 provides the EIRP and path loss values that produce the highest PFD values.

The calculated power densities shown in Table E.1 are low enough to protect radio astronomy measurements.

	Subscriber Transmitter	ORBCOMM Gateway Transmitter	Beacon Transmitter	Units
EIRP at Peak PFD	11.1	11.0	1.5	dBW
Bandwidth Conversion	-39.8	-47.0	0.0	dB/Hz
Spectrum Roll-off	-55.0	-50.0	-130.0	dB
Diplexer/Filter Loss	-30.0	-15.0	0.0	dB
Path Loss at Max. PFD	-136.7	-133.0	-143.3	dB
Power Density	-250.4	-234.0	-271.8	dBW/Hz
RA Band	152	152	406	MHz

**Table E.1 - Out-of-Band Emissions into Radio Astronomy Bands**

### E.3.2 Aeronautical System in the 136-137 MHz Band

To address aeronautical communication concerns over out-of-band transmissions below 137 MHz, the channelization plan proposed by ORBCOMM has its lowest subscriber channel and its lowest Gateway Earth Station (GES) downlink channel located 200 kHz and over 500 kHz from the 137 MHz band edge, respectively. The maximum Doppler shift from a satellite in an orbit 825 km high, at 137 MHz, is approximately 3 kHz or less. The oscillators that control the 137-MHz transmitters are oven-controlled oscillators, and are designed to have less than a 100-Hz drift over the 5-year life of the satellite. As a result, the effects of Doppler and oscillator drift will be insufficient to cause any out-of-band emissions from an ORBCOMM satellite in the aeronautical mobile band.

## Appendix F LIST OF ACRONYMS

A/C	Acquire/Communicate Protocol
ACS	Attitude Control Subsystem
BER	Bit-Error-Rate
COTS	Commercial Off-the-Shelf
CSU/DSU	Channel Service Unit / Data Service Unit
CW	Carrier Wave
DCAAS	Dynamic Channel Activity Assignment System
DSP	Digital Signal Processor
Eb/No	Energy per Bit divided by Noise Density
EIRP	Effective Isotropic Radiated Power
GCC	Gateway Control Center
GES	Gateway Earth Station
GUI	Graphical User Interface
GMSS	Gateway Message Switching System
GPS	Global Positioning System
HP	Hewlett-Packard
HPA	High-Power Amplifier
ICMP	Internet Control Message Protocol
IEEE	Institute of Electrical and Electronics Engineers
IP	Internet Protocol
ISDN	Integrated Services Digital Network
ISP	Internet Service Provider
ITU	International Telecommunications Union
ITU-R	ITU Radiocommunications Sector
ITU-T	ITU Telecommunications Standardization Sector
LEO	Low Earth Orbit
LNA	Low Noise Amplifier
MDC	Message Distribution Center
MetSat	Meteorological Satellite
MHz	Megahertz
MSS	Mobile Satellite Service

---

MTA	X.400 Message Transfer Agent
MTM	MDC Transfer Module
NCC	Network Control Center
NMS	Network Management System
NOAA	National Ocean and Atmospheric Administration
OMG	ORBCOMM Message Gateway
OMS	ORBCOMM Message Switch
OQPSK	Offset Quadrature Phase Shift Keying
OSI	Open System Interconnection
OSPF	Open Shortest Path First
PAD	Packet Assembler/Disassembler
PFD	Power Flux Density
PSTN	Public Switched Telephone Network
RF	Radio Frequency
RHCP	Right-Hand Circularly Polarized
SC	Subscriber Communicator
SCC	Satellite Control Center
SDPSK	Symmetric Differential Phase Shift Keying
SMS	Satellite Management System
SMTP	Simple Mail Transfer Protocol
SNMP	Simple Network Management Protocol
SSP	Satellite Selection Protocol
TCP/IP	Transmission Control Protocol/Internet Protocol
TDMA	Time Division Multiple Access
TLE	Two-Line Orbital Element Set
UDP	User Datagram Protocol
UHF	Ultra High Frequency
UPS	Uninterruptable Power Supply
VHF	Very High Frequency
VPN	Virtual Private Network
VSAT	Very Small Aperture Terminal
WAN	Wide Area Network